

State of Georgia

Office, Computer and Educational Furniture

Contract Number:  
99999-001-SPD0000198-0070

Effective Date: November 1, 2023  
End Date: October 31, 2025

Vendor ID: 0000657741



PRICE LIST

---

**TABLES | ACCESSORIES**

Effective August 15, 2022

special 

## PRICING & FREIGHT NOTIFICATIONS

---

### Pricing Disclaimer

Although the information in this Price List is presented in good faith and believed to be correct at the time of publication, Special-T has no liability for any errors or omissions. Also, please note that all prices are subject to change.

Special-T shall have the right to refuse or cancel any order placed for a product listed at the incorrect price. If an item's correct price is lower than our stated price, we will charge the lower amount and ship the item.

If an item's correct price is higher than our stated price, we will notify the price error for review and extend an opportunity to purchase the item at the correct price.

### Freight Notifications

#### Minimum Freight Fee

FOB: Destination on table orders over 5,000 List.

195 freight fee on orders less than 5,000 List (Prepaid & Add) | Dock-to-Dock delivery.

#### Patriot Electric & Liberty Electric Bases Only

QTY: 1 - 3 55 each | 4-15 33 each | 16 - 50 27 each | 51 + 16 each

FOB: Alpharetta, GA; PPD & ADD | Dock-to-Dock delivery.

#### Shipments Outside Continental U.S.

Qualified Freight Prepaid orders with final destination outside Continental U.S. will ship to the Freight Forwarder or Port of Embarkation within the 48 contiguous states. Shipments from Freight Forwarder/Port of Embarkation will ship FOB: Origin to final destination.

#### Oversize Fee

All LTL shipments for pallets 8' and over

96"-108" - additional 250.00

109"-168" - additional 350.00

Per custom pallet



**TABLES &  
ACCESSORIES  
PRICE LIST**

Effective August 15, 2022

**TABLE OF CONTENTS**

**SHIPPING PROGRAMS** ..... 06

**DESKING SYSTEMS**

AIM EZ Desking ..... 09

**TRAINING AND TASK TABLES**

AIM ..... 18

Antonio ..... 20

Apollo ..... 22

Ella ..... 24

EZ-Roll ..... 27

Kingston ..... 28

Kristina ..... 31

LINK Stationary ..... 34

Portofino-2 ..... 35

Quatro ..... 36

Robot ..... 39

Sienna TL ..... 42

Structure 2TL ..... 43

Structure 2CL ..... 44

Structure H ..... 45

Structure Square ..... 46

**FLIP AND NEST TABLES**

Convertible ..... 48

Kingston Arched Flip ..... 49

Kingston Flip ..... 50

Kingston Flip-C ..... 51

LINK ..... 52

Structure Flip Top-T ..... 54

Structure Flip Top-C ..... 55

Transform-2 ..... 56

**BREAKROOM & CAFE TABLES**

Bedford ..... 58

Bistro ..... 59

Cantina-2 ..... 60

ClassiX ..... 61

Floor Mounted ..... 62

Fusion ..... 64

Maxim ..... 65

Mount ..... 66

Quatro ..... 67

Reveal ..... 68

Sienna Round ..... 70

Sienna Square ..... 71

Sienna Café Power ..... 72

Sienna X ..... 73

Sienna X Café Power ..... 74

StarX-2 ..... 75

Structure 4X ..... 76

Success ..... 77

Tempo ..... 78

**TABLES &  
ACCESSORIES  
PRICE LIST**

Effective August 15, 2022

**TABLE OF CONTENTS**

**CONFERENCE TABLES**

AIM XL .....	80
Astra .....	85
Atlantis .....	87
Benton .....	90
Connect .....	93
Olympus .....	96
Oscar .....	100
Sienna Conference .....	103
Sienna TL .....	106
Sienna 4X .....	109
Sienna Rectangle .....	110
Structure 4X .....	111
Structure Cube .....	114
Venice .....	117

**HEIGHT ADJUSTABLE**

Liberty Electric .....	121
Patriot Electric .....	124

**OCCASIONAL TABLES**    **Not on Contract**

Relax RLX 1 .....	130
Relax RLX 2 .....	132
Relax RLX 3 .....	134
Relax RLX 4 .....	136

**CHAIRS**    **Not on Contract**

Task, Stack, Flipper, Sled .....	139
----------------------------------	-----

**ADJUSTABLE MONITOR ARMS**

Single, Dual, Single with Cross Bar .....	141
---	-----

**SAFE-T SCREENS & BARRIERS**

CLEAR PLEXIGLASS X-SHAPE SAFE-T SCREENS	
X-Shape Safe-T Screens .....	143

**CLEAR PLEXIGLASS SAFE-T SCREENS**

Floor-Standing Safe-T Mobile Divider .....	145
Executive Folding Safe-T Screen .....	145
Safe-T Screen Transaction Screen with Metal Supports .....	145

**CLEAR PLEXIGLASS SAFE-T SCREENS**

Worksurface and Cubicle Screens - Permanent Attachment .....	146
Free-Standing or Permanent Attachment Screens .....	147
Worksurface Screens with Removable C-Clamp .....	148
Free-Standing Screens for Worksurfaces and Cubicles .....	149
Screens for Cubicle Panels with U-Brackets .....	150



**TABLES &  
ACCESSORIES  
PRICE LIST**

---

Effective August 15, 2022

**TABLE OF CONTENTS**

**FROSTED ACRYLIC SAFE-T SCREEN**

Worksurface and Cubicle Screens - Permanent Attachment ..... 151  
 Free-Standing or Permanent Attachment Screens ..... 152  
 Worksurface Screens with Removable C-Clamp ..... 153  
 Free-Standing Screens for Worksurfaces and Cubicles ..... 154  
 Screens for Cubicle Panels with U-Brackets ..... 155

**POLYCARBONATE SAFE-T SCREENS**

Worksurface and Cubicle Screens - Permanent Attachment ..... 156  
 Free-Standing or Permanent Attachment Screens ..... 157  
 Worksurface Screens with Removable C-Clamp ..... 158  
 Free-Standing Screens for Worksurfaces and Cubicles ..... 159  
 Screens for Cubicle Panels with U-Brackets ..... 160

**PET SAFE-T SCREENS**

Worksurface and Cubicle Screens - Permanent Attachment ..... 161  
 Free-Standing or Permanent Attachment Screens ..... 161  
 Worksurface Screens with Removable C-Clamp ..... 162  
 Free-Standing Screens for Worksurfaces and Cubicles ..... 162  
 Screens for Cubicle Panels with U-Brackets ..... 163

Privacy and Modesty Screens ..... 164  
 Sliding Desk Divider ..... 164

Standard Table Features ..... 166  
 Warranty & Return Policy ..... 168  
 Color Options ..... 172



## SHIPPING PROGRAMS

## OPTIONS +

All customization options available to meet any project needs

With the Options+ program, the possibilities are endless. TFL, HPL laminates, and Wood Veneer allow meeting any price point requirement. First, select from multiple tabletop shapes, including rectangle, round, square, boat shape, racetrack, and many more. Next, choose any of our 20 metal and powder coat finishes, any Wilsonart or Formica laminate with or without a matching edge.

Options+ offers multiple edge options, including PVC, Wood, and Urethane edge types.

## QUICK SHIP

---

Cost-effective expedited shipping for time sensitive projects

### 1-DAY

This program meets the needs of projects on a budget or that need a quick turnaround. 1-Day QS orders ship 24 hours after acknowledgment. Select from 50 different base styles in a Black or Metallic Silver, eight durable laminate top colors with matching edges, and rectangle, square, or round table shapes.

### 5-DAY

The 5-Day Quickship program is the perfect solution for tables that must arrive quickly and offers more top color options and sizes. Select from 50 different base styles available in a Black or Metallic Silver finish. In addition, this program has dozens of tabletop sizes available in the most popular colors in the industry.

## SHIPPING PROGRAMS OPTIONS OVERVIEW

OPTION	SHIPPING PROGRAM		
	OPTIONS +	1-DAY	5-DAY
<b>Table Shapes</b>	9 Shapes	Rectangle, Round, and Square	Rectangle, Round, and Square
<b>Laminate Colors</b>	Any WilsonArt or Formica laminate Wood Veneer	8 TFL Colors	13 HPL Colors
<b>Edges</b>	PVC, Urethane, or Wood	3 mm matching edge	3 mm matching or Black PVC
<b>Metal Finishes</b>	20 Colors	Black or Metallic Silver depending on style	Black or Metallic Silver depending on style
<b>Table Heights</b>	Standard - 29" Counter - 36" Bar - 42" Occasional - 17" & 22" Custom - 05" - 42"	Standard - 29" Bar - 42"	Standard - 29" Bar - 42"
<b>Casters</b>	Available	Available	Available
<b>Foot Ring</b>	Available	Available	Available
<b>Modesty Panel</b>	Steel, Laminate or Acrylic	Steel	Steel, Laminate
<b>Privacy Screen</b>	Available	N/A	N/A
<b>Grommets</b>	Available	N/A	Available
<b>Table Connector</b>	Available	Available	Available
<b>Wire Management</b>	Available	Available	Available
<b>Power/Data/USB</b>	Available	Available	Available
<b>Lead Time</b>	15 Days	1 Day	5 Days
<b>GSA Contract</b>	Most Tables	Some Tables	Some Tables



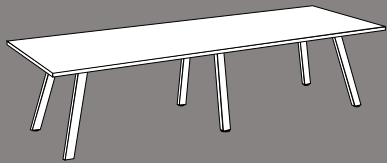

## DESKING SYSTEMS

DESKING SYSTEMS  
**AIM EZ Desking**

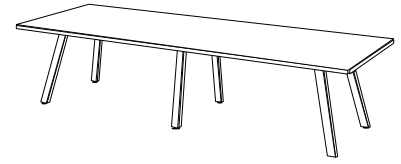

				CONFIGURE & PRICE
	MODEL NUMBER	DESCRIPTION	SIZE	HPL
24" x 48"	AIM-EZ-D-2448-2	24" x 48" Rectangle, 2-pack	24" x 48" (2)	1,721
	AIM-EZ-D-2448-4	24" x 48" Rectangle, 4-pack	24" x 48" (4)	3,289
	AIM-EZ-D-2448-6	24" x 48" Rectangle, 6-pack	24" x 48" (6)	4,859
	AIM-EZ-D-2448-8	24" x 48" Rectangle, 8-pack	24" x 48" (8)	6,429
	AIM-EZ-D-2448-10	24" x 48" Rectangle, 10-pack	24" x 48" (10)	7,996
	AIM-EZ-D-2448-12	24" x 48" Rectangle, 12-pack	24" x 48" (12)	9,566
24" x 60"	AIM-EZ-D-2460-2	24" x 60" Rectangle, 2-pack	24" x 60" (2)	2,048
	AIM-EZ-D-2460-4	24" x 60" Rectangle, 4-pack	24" x 60" (4)	4,025
	AIM-EZ-D-2460-6	24" x 60" Rectangle, 6-pack	24" x 60" (6)	5,921
	AIM-EZ-D-2460-8	24" x 60" Rectangle, 8-pack	24" x 60" (8)	7,818
	AIM-EZ-D-2460-10	24" x 60" Rectangle, 10-pack	24" x 60" (10)	9,713
	AIM-EZ-D-2460-12	24" x 60" Rectangle, 12-pack	24" x 60" (12)	11,611
24" x 72"	AIM-EZ-D-2472-2	24" x 72" Rectangle, 2-pack	24" x 72" (2)	2,239
	AIM-EZ-D-2472-4	24" x 72" Rectangle, 4-pack	24" x 72" (4)	4,350
	AIM-EZ-D-2472-6	24" x 72" Rectangle, 6-pack	24" x 72" (6)	6,409
	AIM-EZ-D-2472-8	24" x 72" Rectangle, 8-pack	24" x 72" (8)	8,468
	AIM-EZ-D-2472-10	24" x 72" Rectangle, 10-pack	24" x 72" (10)	10,529
	AIM-EZ-D-2472-12	24" x 72" Rectangle, 12-pack	24" x 72" (12)	12,587

DESKING SYSTEMS  
**AIM EZ Desking**

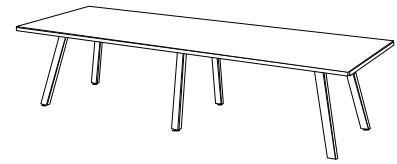

				CONFIGURE & PRICE
	MODEL NUMBER	DESCRIPTION	SIZE	HPL
<b>30" x 48"</b>	AIM-EZ-D-3048-2	30" x 48" Rectangle, 2-pack	30" x 48" (2)	1,877
	AIM-EZ-D-3048-4	30" x 48" Rectangle, 4-pack	30" x 48" (4)	3,601
	AIM-EZ-D-3048-6	30" x 48" Rectangle, 6-pack	30" x 48" (6)	5,327
	AIM-EZ-D-3048-8	30" x 48" Rectangle, 8-pack	30" x 48" (8)	7,049
	AIM-EZ-D-3048-10	30" x 48" Rectangle, 10-pack	30" x 48" (10)	8,775
	AIM-EZ-D-3048-12	30" x 48" Rectangle, 12-pack	30" x 48" (12)	10,499
<b>30" x 60"</b>	AIM-EZ-D-3060-2	30" x 60" Rectangle, 2-pack	30" x 60" (2)	2,237
	AIM-EZ-D-3060-4	30" x 60" Rectangle, 4-pack	30" x 60" (4)	4,173
	AIM-EZ-D-3060-6	30" x 60" Rectangle, 6-pack	30" x 60" (6)	6,259
	AIM-EZ-D-3060-8	30" x 60" Rectangle, 8-pack	30" x 60" (8)	8,346
	AIM-EZ-D-3060-10	30" x 60" Rectangle, 10-pack	30" x 60" (10)	10,432
	AIM-EZ-D-3060-12	30" x 60" Rectangle, 12-pack	30" x 60" (12)	12,518
<b>30" x 72"</b>	AIM-EZ-D-3072-2	30" x 72" Rectangle, 2-pack	30" x 72" (2)	2,463
	AIM-EZ-D-3072-4	30" x 72" Rectangle, 4-pack	30" x 72" (4)	4,799
	AIM-EZ-D-3072-6	30" x 72" Rectangle, 6-pack	30" x 72" (6)	7,083
	AIM-EZ-D-3072-8	30" x 72" Rectangle, 8-pack	30" x 72" (8)	9,366
	AIM-EZ-D-3072-10	30" x 72" Rectangle, 10-pack	30" x 72" (10)	11,649
	AIM-EZ-D-3072-12	30" x 72" Rectangle, 12-pack	30" x 72" (12)	13,932

DESKING SYSTEMS  
**AIM EZ Desking**

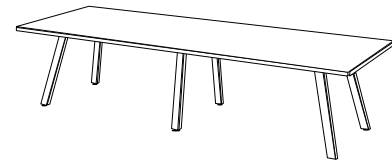

			CONFIGURE & PRICE						
		MODEL NUMBER	DESCRIPTION	2 PACK	4 PACK	6 PACK	8 PACK	10 PACK	12 PACK
<b>Returns</b>		AIM-EZ-1842-RETURN	18" x 42" Rectangle Top Return, HPL	866	1,732	2,598	3,464	4,330	5,196
		AIM-EZ-1848-RETURN	18" x 48" Rectangle Top Return, HPL	886	1,772	2,658	3,544	4,430	5,316
<b>PET Screens</b>	<b>FRONT PANELS</b>	PET-2448-PS-TMB	PET Front Panel, 24" x 48"; Gray	576	1,152	1,728	2,304	2,880	3,456
		PET-2460-PS-TMB	PET Front Panel, 24" x 60"; Gray	779	1,558	2,337	3,116	3,895	4,674
		PET-2472-PS-TMB	PET Front Panel, 24" x 72"; Gray	829	1,658	2,487	3,316	4,145	4,974
	<b>SIDE PANELS</b>	PET-2424-PS-TMB	PET 24" x 24" Side Panel, Gray	-	828	1,656	2,484	3,312	4,140
		PET-2430-PS-TMB	PET 24" x 30" Side Panel, Gray	-	1,008	2,016	3,024	4,032	5,040
	<b>END PANELS</b>	PET-2424-PS-C-BR	PET 24" x 24" End Panel w/C-Clamps, Gray	2,036	2,036	2,036	2,036	2,036	2,036
		PET-2430-PS-C-BR	PET 24" x 30" End Panel w/C-Clamps, Gray	2,396	2,396	2,396	2,396	2,396	2,396
	<b>FRONT PANELS</b>	PET-1448-PS-TMB	PET Front Panel, 14" x 48"; Gray	417	834	1,251	1,668	2,085	2,502
		PET-1460-PS-TMB	PET Front Panel, 14" x 60"; Gray	572	1,144	1,716	2,288	2,860	3,432
		PET-1472-PS-TMB	PET Front Panel, 14" x 72"; Gray	629	1,258	1,887	2,516	3,145	3,774
	<b>SIDE PANELS</b>	PET-1424-PS-TMB	PET 14" x 24" Side Panel, Gray	-	554	1,108	1,662	2,216	2,770
		PET-1430-PS-TMB	PET 14" x 30" Side Panel, Gray	-	726	1,452	2,178	2,904	3,630
	<b>END PANELS</b>	PET-1424-PS-C-BR	PET 14" x 24" End Panel w/C-Clamps, Gray	1,488	1,488	1,488	1,488	1,488	1,488
		PET-1430-PS-C-BR	PET 14" x 30" End Panel w/C-Clamps, Gray	1,832	1,832	1,832	1,832	1,832	1,832

Returns are only available for 60" and 72" worksurfaces

DESKING SYSTEMS  
**AIM EZ Desking**

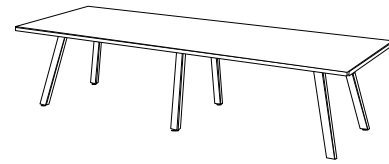

			CONFIGURE & PRICE						
		MODEL NUMBER	DESCRIPTION	2 PACK	4 PACK	6 PACK	8 PACK	10 PACK	12 PACK
Clear Plexiglass Screens	FRONT PANELS	PLEX-3048-PS-TMB	Clear Plexiglass Front Panel, 30" x 48"	659	1,318	1,977	2,636	3,295	3,954
		PLEX-3060-PS-TMB	Clear Plexiglass Front Panel, 30" x 60"	815	1,630	2,445	3,260	4,075	4,890
		PLEX-3072-PS-TMB	Clear Plexiglass Front Panel, 30" x 72"	897	1,794	2,691	3,588	4,485	5,382
	SIDE PANELS	PLEX-3024-PS-TMB	Clear Plexiglass Side Panel, 30" x 24"	-	838	1,676	2,514	3,352	4,190
		PLEX-3030-PS-TMB	Clear Plexiglass Side Panel, 30" x 30"	-	920	1,840	2,760	3,680	4,600
	END PANELS	PLEX-3024-PS-C-BR	Clear Plexiglass End Panel with C-Clamp; 30" x 24"	2,056	2,056	2,056	2,056	2,056	2,056
		PLEX-3030-PS-C-BR	Clear Plexiglass End Panel with C-Clamp; 30" x 30"	2,220	2,220	2,220	2,220	2,220	2,220
	FRONT PANELS	PLEX-2448-PS-TMB	Clear Plexiglass Front Panel, 24" x 48"	397	794	1,191	1,588	1,985	2,382
		PLEX-2460-PS-TMB	Clear Plexiglass Front Panel, 24" x 60"	454	908	1,362	1,816	2,270	2,724
		PLEX-2472-PS-TMB	Clear Plexiglass Front Panel, 24" x 72"	512	1,024	1,536	2,048	2,560	3,072
	SIDE PANELS	PLEX-2424-PS-TMB	Clear Plexiglass Side Panel, 24" x 24"	-	468	936	1,404	1,872	2,340
		PLEX-2430-PS-TMB	Clear Plexiglass Side Panel, 24" x 30"	-	526	1,052	1,578	2,104	2,630
	END PANELS	PLEX-2424-PS-C-BR	Clear Plexiglass End Panel with C-Clamp, 24" x 24"	1,316	1,316	1,316	1,316	1,316	1,316
		PLEX-2430-PS-C-BR	Clear Plexiglass End Panel with C-Clamp, 24" x 30"	1,432	1,432	1,432	1,432	1,432	1,432
	FRONT PANELS	PLEX-1448-PS-TMB	Clear Plexiglass Front Panel, 14" x 48"	257	514	771	1,028	1,285	1,542
		PLEX-1460-PS-TMB	Clear Plexiglass Front Panel, 14" x 60"	333	666	999	1,332	1,665	1,998
		PLEX-1472-PS-TMB	Clear Plexiglass Front Panel, 14" x 72"	368	736	1,104	1,472	1,840	2,208
	SIDE PANELS	PLEX-1424-PS-TMB	Clear Plexiglass Side Panel, 14" x 24"	-	376	752	1,128	1,504	1,880
PLEX-1430-PS-TMB		Clear Plexiglass Side Panel, 14" x 30"	-	398	796	1,194	1,592	1,990	
END PANELS	PLEX-1424-PS-C-BR	Clear Plexiglass End Panel with C-Clamp, 14" x 24"	1,132	1,132	1,132	1,132	1,132	1,132	
	PLEX-1430-PS-C-BR	Clear Plexiglass End Panel with C-Clamp, 14" x 30"	1,176	1,176	1,176	1,176	1,176	1,176	

DESKING SYSTEMS  
**AIM EZ Desking**

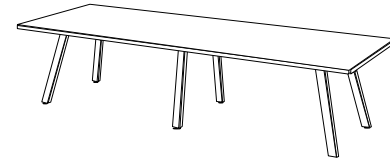

			CONFIGURE & PRICE						
		MODEL NUMBER	DESCRIPTION	2 PACK	4 PACK	6 PACK	8 PACK	10 PACK	12 PACK
Frosted Acrylic Screens	FRONT PANELS	AP-3048-PS-TMB	Frosted Acrylic Front Panel with Permanent Attachment for Benching, 30"H x 48"W, Frosted	1,166	2,332	3,498	4,664	5,830	6,996
		AP-3060-PS-TMB	Frosted Acrylic Front Panel with Permanent Attachment for Benching, 30"H x 60"W, Frosted	1,441	2,882	4,323	5,764	7,205	8,646
		AP-3072-PS-TMB	Frosted Acrylic Front Panel with Permanent Attachment for Benching, 30"H x 72"W, Frosted	1,674	3,348	5,022	6,696	8,370	10,044
	SIDE PANELS	AP-3024-PS-TMB	Frosted Acrylic Side Panel with Permanent Attachment for Benching, 30"H x 24"W, Frosted	-	1,316	2,632	3,948	5,264	6,580
		AP-3030-PS-TMB	Frosted Acrylic Side Panel with Permanent Attachment for Benching, 30"H x 30"W, Frosted	-	1,546	3,092	4,638	6,184	7,730
	END PANELS	AP-3024-PS-C-BR	Frosted Acrylic End Panel w/C-Clamp, 30"H x 24"W, Frosted	3,012	3,012	3,012	3,012	3,012	3,012
		AP-3030-PS-C-BR	Frosted Acrylic End Panel w/C-Clamp, 30"H x 30"W, Frosted	3,472	3,472	3,472	3,472	3,472	3,472
	FRONT PANELS	AP-2448-PS-TMB	Frosted Acrylic Front Panel with Permanent Attachment for Benching, 24"H x 48"W, Frosted	567	1,134	1,701	2,268	2,835	3,402
		AP-2460-PS-TMB	Frosted Acrylic Front Panel with Permanent Attachment for Benching, 24"H x 60"W, Frosted	691	1,382	2,073	2,764	3,455	4,146
		AP-2472-PS-TMB	Frosted Acrylic Front Panel with Permanent Attachment for Benching, 24"H x 72"W, Frosted	815	1,630	2,445	3,260	4,075	4,890
	SIDE PANELS	AP-2424-PS-TMB	Frosted Acrylic Side Panel with Permanent Attachment for Benching, 24"H x 24"W, Frosted	-	602	1,204	1,806	2,408	3,010
		AP-2430-PS-TMB	Frosted Acrylic Side Panel with Permanent Attachment for Benching, 24"H x 30"W, Frosted	-	726	1,452	2,178	2,904	3,630
	END PANELS	AP-2424-PS-C-BR	Frosted Acrylic End Panel w/C-Clamp, 24"H x 24"W, Frosted	1,584	1,584	1,584	1,584	1,584	1,584
		AP-2430-PS-C-BR	Frosted Acrylic End Panel w/C-Clamp, 24"H x 30"W, Frosted	1,832	1,832	1,832	1,832	1,832	1,832
	FRONT PANELS	AP-1448-PS-TMB	Frosted Acrylic Front Panel with Permanent Attachment for Benching, 14"H x 48"W, Frosted	426	852	1,278	1,704	2,130	2,556
		AP-1460-PS-TMB	Frosted Acrylic Front Panel with Permanent Attachment for Benching, 14"H x 60"W, Frosted	505	1,010	1,515	2,020	2,525	3,030
		AP-1472-PS-TMB	Frosted Acrylic Front Panel with Permanent Attachment for Benching, 14"H x 72"W, Frosted	572	1,144	1,716	2,288	2,860	3,432
	SIDE PANELS	AP-1424-PS-TMB	Frosted Acrylic Side Panel with Permanent Attachment for Benching, 14"H x 24"W, Frosted	-	466	932	1,398	1,864	2,330
		AP-1430-PS-TMB	Frosted Acrylic Side Panel with Permanent Attachment for Benching, 14"H x 30"W, Frosted	-	466	932	1,398	1,864	2,330
	END PANELS	AP-1424-PS-C-BR	Frosted Acrylic End Panel w/C-Clamp, 14"H x 24"W, Frosted	1,312	1,312	1,312	1,312	1,312	1,312
		AP-1430-PS-C-BR	Frosted Acrylic End Panel w/C-Clamp, 14"H x 30"W, Frosted	1,312	1,312	1,312	1,312	1,312	1,312

DESKING SYSTEMS  
**AIM EZ Desking**

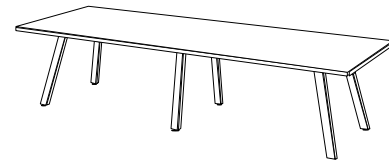

			CONFIGURE & PRICE						
			2 PACK	4 PACK	6 PACK	8 PACK	10 PACK	12 PACK	
Electrical	MODEL NUMBER	DESCRIPTION							
	BURELE-2P	Burele 2 Power	438	876	1,314	1,752	2,190	2,628	
	BURELE-1P1U	Burele 1 Power / 1 USB Duplex	622	1,244	1,866	2,488	3,110	3,732	
	EZPOWER-3P1U	EZ Power 3 Power / 1 USB Duplex	494	988	1,482	1,976	2,470	2,964	
	VIL2U-41-D-K	2 Power / 1 USB Duplex / 2 Data Knockouts / Convenience Outlet, 1 unit	1,362	2,724	4,086	5,448	6,810	8,172	
	<b>STARTER CORD</b>								
	4220AP1-72	Starter 72" Plug Cord	248	496	496	496	496	496	
42SB2-72	Starter 72" Hardwire	179	358	358	358	358	358		

Wire Management	HORIZONTAL	WM-LOOPCLIP	Pkg of 4 clips w/ screws	10	20	30	40	50	60
		WM-VELCRO	Pkg of 4 velcro hook & loop	28	56	84	112	140	168
		WM-CABLE-GRIP	Wire management grip - holds 5 cords	34	68	102	136	170	204
		JWM-4	J-channel wire manager 48" long, black	98	196	294	392	490	588
		JWM-5	J-channel wire manager 60" long, black	122	244	366	488	610	732
		JWM-6	J-channel wire manager 72" long, black	146	292	438	584	730	876
		WM-SNAP-CHANNEL	32" long plastic latching wire manager, black	38	76	114	152	190	228
		WM-TROUGH-B	27.6" metal wire management trough	70	140	210	280	350	420
	VERTICAL	WM-MAG-CHANNEL	1" x 2" metal channel with magnetic attachment	198	396	594	792	990	1,188
	WM-SPINE-TR	51" Spine wire manager Kit, 2 mag clips,translucent	462	924	1,386	1,848	2,310	2,772	
WM-INT	Base-integrated vertical wire management	146	292	438	584	730	876		

DESKING SYSTEMS  
**AIM EZ Desking**

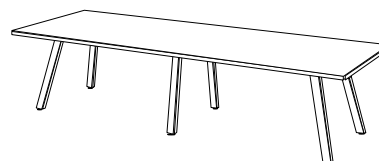

			CONFIGURE & PRICE					
	MODEL NUMBER	DESCRIPTION	2 PACK	4 PACK	6 PACK	8 PACK	10 PACK	12 PACK
<b>Pedestals</b>	PED-HANG	Hanging Slim Pedestal	1,346	2,692	4,038	5,384	6,730	8,076
	PED-1B1F*	1 box, 1 file Pedestal with Casters	1,246	2,492	3,738	4,984	6,230	7,476
	PED-CUSHION	Removable seat cushion	560	1,120	1,680	2,240	2,800	3,360
<b>Monitor Arms</b>	MA-S1-A1	Adjustable Monitor Arm, Single	804	1,608	2,412	3,216	4,020	4,824
	MA-S1-A2	Adjustable Monitor Arm, Dual	1,416	2,832	4,248	5,664	7,080	8,496
	MA-S1-X2	Adjustable Monitor Arm, with a cross bar to support 2 monitors	1,148	2,296	3,444	4,592	5,740	6,888
<b>Chairs</b>	CH-TASK	Task Chair, Standard Height, Black/Grey, with arms, with casters	1,516	3,032	4,548	6,064	7,580	9,096
	CH-STACK	Stacking Chair, Standard Height, Black/Silver, with arms	1,130	2,260	3,390	4,520	5,650	6,780
	CH-FLIP	Flipper Chair, Standard Height, Black/Silver, with arms, with casters	1,346	2,692	4,038	5,384	6,730	8,076

\*Not available for 48" long tables



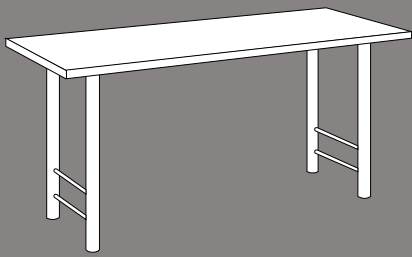

## TRAINING & TASK TABLES

TRAINING & TASK TABLES

**AIM**

CONFIGURE & PRICE

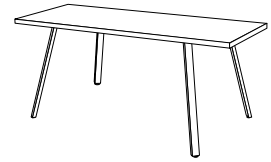

	MODEL NUMBER	SIZE	HPL	WOOD VENEER	1-DAY	5-DAY
Rectangle	AIM-2448	24 x 48	978	1,819	-	-
	AIM-2454	24 x 54	1,034	1,942	-	-
	AIM-2460	24 x 60	1,044	2,069	-	-
	AIM-2466	24 x 66	1,114	2,207	-	-
	AIM-2472	24 x 72	1,212	2,424	-	-
	AIM-3048	30 x 48	1,092	2,198	-	-
	AIM-3054	30 x 54	1,103	2,294	-	-
	AIM-3060	30 x 60	1,114	2,463	-	-
	AIM-3066	30 x 66	1,284	3,717	-	-
	AIM-3072	30 x 72	1,304	2,894	-	-
	AIM-3648	36 x 48	1,333	2,499	-	-
	AIM-3654	36 x 54	1,460	2,717	-	-
	AIM-3660	36 x 60	1,472	2,897	-	-
	AIM-3666	36 x 66	1,675	3,189	-	-
	AIM-3672	36 x 72	1,688	3,367	-	-
Round	AIM-36R	36"	1,093	1,872	-	-
	AIM-42R	42"	1,214	2,176	-	-
	AIM-48R	48"	1,256	2,587	-	-
	AIM-54R	54"	1,533	3,047	-	-
	AIM-60R	60"	1,576	3,555	-	-
Square	AIM-3636	36 x 36	866	1,777	-	-
	AIM-4242	42 x 42	1,029	2,116	-	-
	AIM-4848	48 x 48	1,279	2,774	-	-
	AIM-5454	54 x 54	1,394	3,113	-	-
	AIM-6060	60 x 60	1,400	3,619	-	-

## TRAINING & TASK TABLES

### AIM



#### AIM Options

MODEL NUMBER	DESCRIPTION	ADD-ON
-CH	Counter Height 36"	30
-BH	Bar Height 42"	60
-CA-P	Premium Casters	60

#### Accessories for Training Tables

OPTION	DESCRIPTION	PRICE
Modesty Panels	PET, Perforated Steel, Laminate, Frosted Acrylic	Visit SpecialT.net
Privacy Screens	PET, Frosted Acrylic, Clear Plexiglass	
Grommets	Round or Rectangle	
Power & Data Management	Burele, EZ Power, Ashley Duo Air, Cove, Dean, Nacre, Node, Mho B, Villa, Qi Wireless Charger	
Wire Management	Loop Clips, Velcro Loop, Cable Grip, J-Shape Wire Channel, Snap Wire Channel, Wire Tough, Wire Tray, 1" Wire Channel, Magnetic Channel, Adjustable Spine	
Table Connector	Quick Align	
Chairs	Task, Stacking, Flipper, Sled	
Monitor Arms	Single, Dual, Single Arm with Cross Bar	

TRAINING & TASK TABLES

**Antonio**

CONFIGURE & PRICE

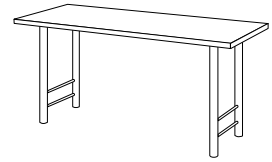

	MODEL NUMBER	SIZE	HPL	WOOD VENEER	1-DAY	5-DAY
Rectangle	ANTO-2430	24 x 30	787	1,340	-	865
	ANTO-2436	24 x 36	818	1,498	-	900
	ANTO-2442	24 x 42	833	1,555	-	918
	ANTO-2448	24 x 48	873	1,714	679	961
	ANTO-2454	24 x 54	905	1,813	-	995
	ANTO-2460	24 x 60	939	1,964	745	1,032
	ANTO-2466	24 x 66	1,054	2,147	-	1,160
	ANTO-2472	24 x 72	1,108	2,320	913	1,220
	ANTO-2478	24 x 78	1,162	2,441	-	1,278
	ANTO-2484	24 x 84	1,308	2,679	-	1,438
	ANTO-2496	24 x 96	1,425	3,008	-	1,567
	ANTO-3042	30 x 42	912	1,860	-	1,003
	ANTO-3048	30 x 48	963	2,069	-	1,060
	ANTO-3054	30 x 54	1,018	2,209	-	1,119
	ANTO-3060	30 x 60	1,075	2,424	882	1,184
	ANTO-3066	30 x 66	1,175	2,608	-	1,292
	ANTO-3072	30 x 72	1,253	2,843	1,060	1,378
	ANTO-3078	30 x 78	1,349	3,027	-	1,483
	ANTO-3084	30 x 84	1,558	3,401	-	1,713
	ANTO-3096	30 x 96	1,656	3,788	-	1,821
	ANTO-3642	36 x 42	1,022	2,022	-	1,126
	ANTO-3648	36 x 48	1,075	2,241	-	1,184
	ANTO-3654	36 x 54	1,126	2,383	-	1,239
	ANTO-3660	36 x 60	1,263	2,688	-	1,328
	ANTO-3666	36 x 66	1,423	2,937	-	1,498
	ANTO-3672	36 x 72	1,466	3,145	-	1,546
	ANTO-3678	36 x 78	1,623	3,393	-	1,714
	ANTO-3684	36 x 84	1,743	3,640	-	1,831
	ANTO-3696	36 x 96	1,840	4,033	-	1,941
	Trapezoid	ANTO-2448-TRA	24 x 48	905	-	-
ANTO-2460-TRA		24 x 60	977	-	-	-
ANTO-2472-TRA		24 x 72	1,153	-	-	-
ANTO-3048-TRA		30 x 48	999	-	-	-
ANTO-3060-TRA		30 x 60	1,121	2,135	-	-
ANTO-3072-TRA		30 x 72	1,308	2,492	-	-

## TRAINING & TASK TABLES

### Antonio

CONFIGURE & PRICE

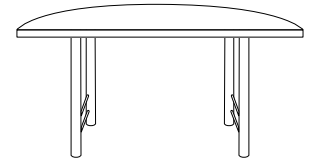

	MODEL NUMBER	SIZE	HPL	WOOD VENEER	1-DAY	5-DAY
1/2 Round	ANTO-3060-HRD	30 x 60	1,257	2,322	-	-
	ANTO-3672-HRD	36 x 72	1,830	3,387	-	-
1/4 Round	ANTO-3030-QRD	30 x 30	1,036	1,615	-	-
	ANTO-3636-QRD	36 x 36	1,154	1,944	-	-
Crescent	ANTO-2472-CRE	24 x 48 x 72	1,473	2,605	-	-
	ANTO-2494-CRE	24 x 60 x 94	2,053	3,657	-	-
	ANTO-3072-CRE	30 x 48 x 72	1,496	2,827	-	-
	ANTO-3094-CRE	30 x 60 x 94	2,074	3,841	-	-

### Antonio Options

MODEL NUMBER	DESCRIPTION	ADD-ON
-CA	Casters	76
-CH	Counter Height 36"	252
-BH	Bar Height 42"	252
-CUSTHT1	Custom Height between 5" - 28.99"	272
-CUSTHT2	Custom Height between 29" - 42"	524

### Accessories for Training Tables

OPTION	DESCRIPTION	PRICE
Modesty Panels	PET, Perforated Steel, Laminate, Frosted Acrylic	Visit SpecialT.net
Privacy Screens	PET, Frosted Acrylic, Clear Plexiglass	
Grommets	Round or Rectangle	
Power & Data Management	Burele, EZ Power, Ashley Duo Air, Cove, Dean, Nacre, Node, Mho B, Villa, Qi Wireless Charger	
Wire Management	Loop Clips, Velcro Loop, Cable Grip, J-Shape Wire Channel, Snap Wire Channel, Wire Tough, Wire Tray, 1" Wire Channel, Magnetic Channel, Adjustable Spine	
Table Connector	Quick Align	
Chairs	Task, Stacking, Flipper, Sled	
Monitor Arms	Single, Dual, Single Arm with Cross Bar	

\*An Oversize Fee has been implemented by freight carriers for all LTL shipments for pallets 8' and over.  
96"-108" - additional 250.00 | 109" -168" - additional 350.00 | Per custom pallet

TRAINING & TASK TABLES

**Apollo**

CONFIGURE & PRICE

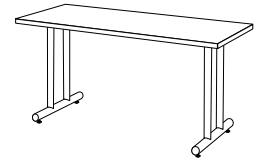

	MODEL NUMBER	SIZE	HPL	WOOD VENEER	1-DAY	5-DAY	
Rectangle	APOL-2436	24 x 36	933	1,613	-	1,026	
	APOL-2442	24 x 42	973	1,695	-	1,070	
	APOL-2448	24 x 48	1,008	1,849	816	1,109	
	APOL-2454	24 x 54	1,042	1,950	-	1,146	
	APOL-2460	24 x 60	1,078	2,103	884	1,186	
	APOL-2466	24 x 66	1,191	2,284	-	1,309	
	APOL-2472	24 x 72	1,243	2,455	1,051	1,369	
	APOL-2478	24 x 78	1,345	2,624	-	1,479	
	APOL-2484	24 x 84	1,444	2,815	-	1,589	
	APOL-2496	24 x 96	1,561	3,144	-	1,716	
	APOL-3042	30 x 42	1,030	1,978	-	1,132	
	APOL-3048	30 x 48	1,078	2,184	-	1,186	
	APOL-3054	30 x 54	1,132	2,323	-	1,245	
	APOL-3060	30 x 60	1,190	2,539	994	1,308	
	APOL-3066	30 x 66	1,291	2,724	-	1,419	
	APOL-3072	30 x 72	1,368	2,958	1,174	1,505	
	APOL-3078	30 x 78	1,518	3,196	-	1,670	
	APOL-3084	30 x 84	1,671	3,514	-	1,837	
	APOL-3096	30 x 96	1,768	3,900	-	1,945	
	APOL-3642	36 x 42	1,136	2,136	-	1,249	
	APOL-3648	36 x 48	1,190	2,356	-	1,308	
	APOL-3654	36 x 54	1,259	2,516	-	1,385	
	APOL-3660	36 x 60	1,381	2,806	-	1,454	
	APOL-3666	36 x 66	1,542	3,056	-	1,622	
	APOL-3672	36 x 72	1,665	3,344	-	1,752	
	APOL-3678	36 x 78	1,833	3,603	-	1,930	
	APOL-3684	36 x 84	1,951	3,848	-	2,053	
	APOL-3696	36 x 96	2,061	4,254	-	2,166	
	Trapezoid	APOL-2460-TRA	24 x 60	1,217	-	-	-
		APOL-2472-TRA	24 x 72	1,401	-	-	-
APOL-3048-TRA		30 x 48	1,240	-	-	-	
APOL-3060-TRA		30 x 60	1,371	2,385	-	-	
APOL-3072-TRA		30 x 72	1,564	2,748	-	-	

## TRAINING & TASK TABLES

### Apollo

CONFIGURE & PRICE

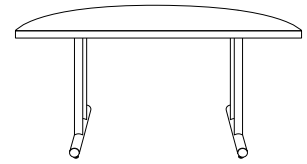

	MODEL NUMBER	SIZE	HPL	WOOD VENEER	1-DAY	5-DAY
1/2 Round	APOL-6030-HRD	60 x 30	1,514	2,579	-	-
	APOL-7236-HRD	72 x 36	1,830	3,387	-	-
1/4 Round	APOL-3030-QRD	30 x 30	1,281	1,860	-	-
	APOL-3636-QRD	36 x 36	1,404	2,194	-	-
Crescent	APOL-2472-CRE	24 x 48 x 72	1,701	2,833	-	-
	APOL-2494-CRE	24 x 60 x 94	2,312	3,916	-	-
	APOL-3072-CRE	30 x 48 x 72	1,724	3,055	-	-
	APOL-3094-CRE	30 x 60 x 94	2,337	4,104	-	-

### Apollo Options

MODEL NUMBER	DESCRIPTION	ADD-ON
-TL	T-Leg Option	0
-CL	C-Leg Option	0
-CA	Casters	76
-CH	Counter Height 36"	252
-BH	Bar Height 42"	252
-CUSTHT1	Custom Height between 5" - 28.99"	272
-CUSTHT2	Custom Height between 29" - 42"	524

### Accessories for Training Tables

OPTION	DESCRIPTION	PRICE
Modesty Panels	PET, Perforated Steel, Laminate, Frosted Acrylic	Visit SpecialT.net
Privacy Screens	PET, Frosted Acrylic, Clear Plexiglass	
Grommets	Round or Rectangle	
Power & Data Management	Burele, EZ Power, Ashley Duo Air, Cove, Dean, Nacre, Node, Mho B, Villa, Qi Wireless Charger	
Wire Management	Loop Clips, Velcro Loop, Cable Grip, J-Shape Wire Channel, Snap Wire Channel, Wire Tough, Wire Tray, 1" Wire Channel, Magnetic Channel, Adjustable Spine	
Table Connector	Quick Align	
Chairs	Task, Stacking, Flipper, Sled	
Monitor Arms	Single, Dual, Single Arm with Cross Bar	

\*An Oversize Fee has been implemented by freight carriers for all LTL shipments for pallets 8' and over.  
96"-108" - additional 250.00 | 109"-168" - additional 350.00 | Per custom pallet

TRAINING & TASK TABLES

**Ella**

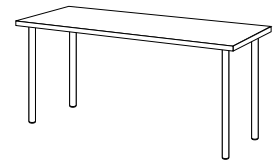

CONFIGURE & PRICE

	MODEL NUMBER	SIZE	CONFIGURE & PRICE		1-DAY	5-DAY
			HPL	WOOD VENEER		
Rectangle	ELLA-1824	18 x 24	652	1,020	-	717
	ELLA-1830	18 x 30	679	1,112	-	746
	ELLA-1836	18 x 36	693	1,205	-	763
	ELLA-1842	18 x 42	732	1,297	-	805
	ELLA-1848	18 x 48	778	1,436	-	855
	ELLA-1854	18 x 54	802	1,512	-	884
	ELLA-1860	18 x 60	823	1,628	627	906
	ELLA-1866	18 x 66	911	1,767	-	1,001
	ELLA-1872	18 x 72	963	1,913	769	1,060
	ELLA-1878	18 x 78	1,094	2,095	-	1,203
	ELLA-1884	18 x 84	1,225	2,300	-	1,347
	ELLA-1896	18 x 96	1,314	2,556	-	1,446
	ELLA-2430	24 x 30	721	1,274	-	792
	ELLA-2436	24 x 36	751	1,431	-	825
	ELLA-2442	24 x 42	785	1,507	-	862
	ELLA-2448	24 x 48	823	1,664	627	906
	ELLA-2454	24 x 54	860	1,768	-	946
	ELLA-2460	24 x 60	898	1,923	702	986
	ELLA-2466	24 x 66	1,017	2,110	-	1,118
	ELLA-2472	24 x 72	1,075	2,287	882	1,184
	ELLA-2478	24 x 78	1,180	2,459	-	1,298
	ELLA-2484	24 x 84	1,284	2,655	-	1,413
	ELLA-2496	24 x 96	1,407	2,990	-	1,547
	ELLA-3036	30 x 36	803	-	-	885
	ELLA-3042	30 x 42	844	1,792	-	929
	ELLA-3048	30 x 48	898	2,004	-	986
	ELLA-3054	30 x 54	956	2,147	-	1,053
	ELLA-3060	30 x 60	1,015	2,364	821	1,116
	ELLA-3066	30 x 66	1,111	2,544	-	1,223
	ELLA-3072	30 x 72	1,204	2,794	1,008	1,324
	ELLA-3078	30 x 78	1,364	3,042	-	1,501
	ELLA-3084	30 x 84	1,525	3,368	-	1,675
	ELLA-3096	30 x 96	1,627	3,759	-	1,791



TRAINING & TASK TABLES

**Ella**

**CONFIGURE & PRICE**

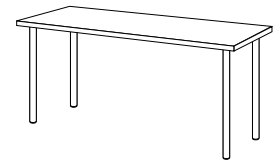

	MODEL NUMBER	SIZE	HPL	WOOD VENEER	1-DAY	5-DAY
Rectangle	ELLA-3642	36 x 42	960	1,960	-	1,055
	ELLA-3648	36 x 48	1,015	2,181	-	1,116
	ELLA-3654	36 x 54	1,085	2,342	-	1,193
	ELLA-3660	36 x 60	1,154	2,579	-	1,271
	ELLA-3666	36 x 66	1,315	2,829	-	1,447
	ELLA-3672	36 x 72	1,364	3,043	-	1,501
	ELLA-3678	36 x 78	1,502	3,272	-	1,653
	ELLA-3684	36 x 84	1,638	3,535	-	1,801
ELLA-3696	36 x 96	1,745	3,938	-	1,919	
Round	ELLA-24	24"	847	1,216	-	975
	ELLA-30	30"	939	1,506	-	1,081
	ELLA-36	36"	1,054	1,833	860	1,214
	ELLA-42	42"	1,212	2,174	1,017	1,393
	ELLA-48	48"	1,353	2,684	-	1,558
	ELLA-60	60"	1,898	3,877	-	2,185
Square	ELLA-2424	24 x 24	819	1,287	-	943
	ELLA-3030	30 x 30	905	1,567	-	1,041
	ELLA-3636	36 x 36	1,006	1,917	812	1,158
	ELLA-4242	42 x 42	1,147	2,234	953	1,320
	ELLA-4848	48 x 48	1,281	2,776	-	1,474
Trapezoid	ELLA-1848-TRA	18 x 48	809	-	-	-
	ELLA-1860-TRA	18 x 60	856	-	-	-
	ELLA-1872-TRA	18 x 72	1,003	-	-	-
	ELLA-2448-TRA	24 x 48	856	-	-	-
	ELLA-2460-TRA	24 x 60	934	-	-	-
	ELLA-2472-TRA	24 x 72	1,120	-	-	-
	ELLA-3048-TRA	30 x 48	934	-	-	-
	ELLA-3060-TRA	30 x 60	1,065	2,079	-	-
ELLA-3072-TRA	30 x 72	1,261	2,445	-	-	
1/2 Round	ELLA-3618-HRD	36 x 18	818	1,300	-	-
	ELLA-4824-HRD	48 x 24	976	-	-	-
	ELLA-6030-HRD	60 x 30	1,206	2,271	-	-
	ELLA-7236-HRD	72 x 36	1,525	3,082	-	-

## TRAINING & TASK TABLES

### Ella

CONFIGURE & PRICE

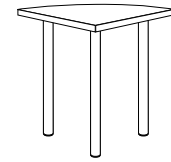

	MODEL NUMBER	SIZE	HPL	WOOD VENEER	1-DAY	5-DAY
1/4 Round	ELLA-1818-QRD	18 x 18	627	817	-	-
	ELLA-2424-QRD	24 x 24	675	1,067	-	-
	ELLA-3030-QRD	30 x 30	781	1,360	-	-
	ELLA-3636-QRD	36 x 36	910	1,700	-	-
Crescent	ELLA-1872-CRE	18 x 48 x 72	1,419	-	-	-
	ELLA-1894-CRE	18 x 60 x 94	2,031	-	-	-
	ELLA-2472-CRE	24 x 48 x 72	1,419	2,551	-	-
	ELLA-2494-CRE	24 x 60 x 94	2,031	3,635	-	-
	ELLA-3072-CRE	30 x 48 x 72	1,419	2,750	-	-
	ELLA-3094-CRE	30 x 60 x 94	2,031	3,798	-	-

### Ella Options

MODEL NUMBER	DESCRIPTION	ADD-ON	
		TABLES UNDER 84" LONG	TABLES 84" & LONGER
-2	2" Diameter	0	0
-3	3" Diameter	144	216
-4	4" diameter	304	456
-FM	Folding Legs	632	948
-CA	Castors	76	114
-BH	Bar Height 42"	252	378
-CUSTHT1	Custom Height between 5" - 28.99"	272	408
-CUSTHT2	Custom Height between 29" - 42"	524	786

### Accessories for Training Tables

OPTION	DESCRIPTION	PRICE
Modesty Panels	PET, Perforated Steel, Laminate, Frosted Acrylic	Visit SpecialT.net
Privacy Screens	PET, Frosted Acrylic, Clear Plexiglass	
Grommets	Round or Rectangle	
Power & Data Management	Burele, EZ Power, Ashley Duo Air, Cove, Dean, Nacre, Node, Mho B, Villa, Qi Wireless Charger	
Wire Management	Loop Clips, Velcro Loop, Cable Grip, J-Shape Wire Channel, Snap Wire Channel, Wire Tough, Wire Tray, 1" Wire Channel, Magnetic Channel, Adjustable Spine	
Table Connector	Quick Align	
Chairs	Task, Stacking, Flipper, Sled	
Monitor Arms	Single, Dual, Single Arm with Cross Bar	

\*An Oversize Fee has been implemented by freight carriers for all LTL shipments for pallets 8' and over.  
96"-108" - additional 250.00 | 109" -168" - additional 350.00 | Per custom pallet

TRAINING & TASK TABLES

**EZ-Roll**

CONFIGURE & PRICE

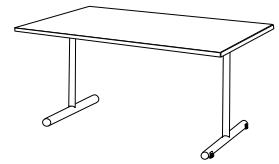

	MODEL NUMBER	SIZE	HPL	WOOD VENEER	1-DAY	5-DAY
Rectangle	EZRL-1824	18 x 24	754	1,122	-	861
	EZRL-1830	18 x 30	773	1,206	-	851
	EZRL-1836	18 x 36	792	1,304	-	869
	EZRL-1842	18 x 42	796	1,361	-	875
	EZRL-1848	18 x 48	839	1,497	-	922
	EZRL-1854	18 x 54	856	1,566	-	942
	EZRL-1860	18 x 60	878	1,683	691	965
	EZRL-1866	18 x 66	957	1,813	-	1,058
	EZRL-1872	18 x 72	1,007	1,957	820	1,106
	EZRL-1878	18 x 78	1,139	2,140	-	1,252
	EZRL-2430	24 x 30	795	1,348	-	874
	EZRL-2436	24 x 36	823	1,503	-	905
	EZRL-2442	24 x 42	843	1,565	-	928
	EZRL-2448	24 x 48	878	1,719	691	965
	EZRL-2454	24 x 54	912	1,820	-	1,001
	EZRL-2460	24 x 60	945	1,970	757	1,039
	EZRL-2466	24 x 66	1,054	2,147	-	1,159
	EZRL-2472	24 x 72	1,107	2,319	922	1,218
	EZRL-2478	24 x 78	1,194	2,473	-	1,314
	EZRL-3042	30 x 42	898	1,846	-	987
	EZRL-3048	30 x 48	945	2,051	-	1,039
	EZRL-3054	30 x 54	998	2,189	-	1,097
	EZRL-3060	30 x 60	1,053	2,402	866	1,158
	EZRL-3066	30 x 66	1,150	2,583	-	1,265
	EZRL-3072	30 x 72	1,225	2,815	1,038	1,348
	EZRL-3078	30 x 78	1,352	3,030	-	1,489

**EZ-Roll Options**

MODEL NUMBER	DESCRIPTION	ADD-ON
-CUSTHT1	Custom Height between 5" - 28.99"	136

**Accessories for Training Tables**

OPTION	DESCRIPTION	PRICE
Modesty Panels	PET, Perforated Steel, Laminate, Frosted Acrylic	Visit SpecialT.net
Privacy Screens	PET, Frosted Acrylic, Clear Plexiglass	
Grommets	Round or Rectangle	
Power & Data Management	Burele, EZ Power, Ashley Duo Air, Cove, Dean, Nacre, Node, Mho B, Villa, Qi Wireless Charger	
Wire Management	Loop Clips, Velcro Loop, Cable Grip, J-Shape Wire Channel, Snap Wire Channel, Wire Tough, Wire Tray, 1" Wire Channel, Magnetic Channel, Adjustable Spine	
Table Connector	Quick Align	
Chairs	Task, Stacking, Flipper, Sled	
Monitor Arms	Single, Dual, Single Arm with Cross Bar	

TRAINING & TASK TABLES

**Kingston**

CONFIGURE & PRICE

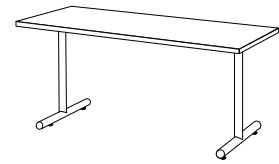

	MODEL NUMBER	SIZE	HPL	WOOD VENEER	1-DAY	5-DAY
Rectangle	KING-1824	18 x 24	675	1,043	-	743
	KING-1830	18 x 30	697	1,130	-	766
	KING-1836	18 x 36	715	1,227	-	787
	KING-1842	18 x 42	751	1,316	-	824
	KING-1848	18 x 48	792	1,450	-	869
	KING-1854	18 x 54	813	1,523	-	893
	KING-1860	18 x 60	831	1,636	646	915
	KING-1866	18 x 66	913	1,769	-	1,007
	KING-1872	18 x 72	962	1,912	773	1,058
	KING-1878	18 x 78	1,055	2,056	-	1,162
	KING-1884	18 x 84	1,198	2,273	-	1,317
	KING-1896	18 x 96	1,279	2,521	-	1,407
	KING-18108	18 x 108	1,686	3,842	-	1,854
	KING-18120	18 x 120	1,854	4,205	-	2,039
	KING-2430	24 x 30	752	1,305	-	825
	KING-2436	24 x 36	780	1,460	-	860
	KING-2442	24 x 42	797	1,519	-	877
	KING-2448	24 x 48	831	1,672	646	915
	KING-2454	24 x 54	866	1,774	-	952
	KING-2460	24 x 60	899	1,924	712	988
	KING-2466	24 x 66	1,008	2,101	-	1,107
	KING-2472	24 x 72	1,062	2,274	874	1,169
	KING-2478	24 x 78	1,111	2,390	-	1,224
	KING-2484	24 x 84	1,251	2,622	-	1,377
	KING-2496	24 x 96	1,366	2,949	-	1,504
	KING-24108	24 x 108	1,770	4,295	-	1,949
	KING-24120	24 x 120	1,910	4,682	-	2,101
	KING-3042	30 x 42	851	1,799	-	935
	KING-3048	30 x 48	899	2,005	-	988
	KING-3054	30 x 54	951	2,142	-	1,045
	KING-3060	30 x 60	1,007	2,356	820	1,106
	KING-3066	30 x 66	1,104	2,537	-	1,214
	KING-3072	30 x 72	1,180	2,770	994	1,297
KING-3078	30 x 78	1,272	2,950	-	1,399	
KING-3084	30 x 84	1,471	3,314	-	1,619	

TRAINING & TASK TABLES

**Kingston**

**CONFIGURE & PRICE**

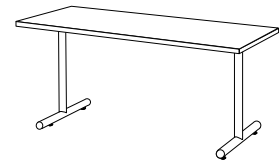

	MODEL NUMBER	SIZE	HPL	WOOD VENEER	1-DAY	5-DAY
Rectangle	KING-3096	30 x 96	1,566	3,698	-	1,723
	KING-30108	30 x 108	1,932	5,232	-	2,126
	KING-30120	30 x 120	2,110	5,573	-	2,321
	KING-3642-TL	36 x 42	954	1,954	-	1,051
	KING-3648-TL	36 x 48	1,007	2,173	-	1,106
	KING-3654-TL	36 x 54	1,054	2,311	-	1,159
	KING-3660-TL	36 x 60	1,133	2,558	-	1,247
	KING-3666-TL	36 x 66	1,279	2,793	-	1,407
	KING-3672-TL	36 x 72	1,324	3,003	-	1,458
	KING-3678-TL	36 x 78	1,474	3,244	-	1,622
	KING-3684-TL	36 x 84	1,576	3,473	-	1,734
	KING-3696-TL	36 x 96	1,671	3,864	-	1,836
Trapezoid	KING-1848-TRA	18 x 48	820	-	-	-
	KING-1860-TRA	18 x 60	865	-	-	-
	KING-1872-TRA	18 x 72	996	-	-	-
	KING-2448-TRA	24 x 48	865	-	-	-
	KING-2460-TRA	24 x 60	935	-	-	-
	KING-2472-TRA	24 x 72	1,103	-	-	-
	KING-3048-TRA	30 x 48	933	-	-	-
	KING-3060-TRA	30 x 60	1,053	2,067	-	-
	KING-3072-TRA	30 x 72	1,230	2,414	-	-
1/2 Round	KING-3618-HRD	18 x 36	827	1,309	-	-
	KING-4824-HRD	24 x 48	972	-	-	-
	KING-6030-HRD	30 x 60	1,181	2,246	-	-
	KING-7236-HRD	36 x 72	1,471	3,028	-	-
1/4 Round	KING-1818-QRD	18 x 18	828	1,018	-	-
	KING-2424-QRD	24 x 24	869	1,261	-	-
	KING-3030-QRD	30 x 30	970	1,549	-	-
	KING-3636-QRD	36 x 36	1,082	1,872	-	-
Crescent	KING-1872-CRE	18 x 48 x 72	1,411	-	-	-
	KING-1894-CRE	18 x 60 x 94	1,969	-	-	-
	KING-2472-CRE	24 x 48 x 72	1,411	2,543	-	-
	KING-2494-CRE	24 x 60 x 94	1,969	3,573	-	-
	KING-3072-CRE	30 x 48 x 72	1,411	2,742	-	-
	KING-3094-CRE	30 x 60 x 94	1,969	3,736	-	-

## TRAINING & TASK TABLES

# Kingston

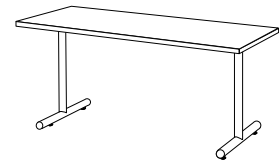

### Kingston Options

MODEL NUMBER	DESCRIPTION	ADD-ON	
		TABLES UP TO 84" LONG	TABLES 96"-120" LONG
-TL	T-Leg Option	-	-
-CL	C-Leg Option	-	-
-ATL	Arched Leg Option	142	-
-SLG	Self Leveling Glides	84	-
-CA	Casters	76	114
-SC	Skate Casters	128	-
-FL	Folding Legs	496	744
-AH	Adjustable Height 26" to 36"	218	327
-AH42	Adjustable Height 36" to 42"	418	627
-CH	Counter Height 36"	126	189
-BH	Bar Height 42"	126	189
-CUSTHT1	Custom Height between 5" - 28.99"	136	204
-CUSTHT2	Custom Height between 29" - 42"	262	393

### Accessories for Training Tables

OPTION	DESCRIPTION	PRICE
Modesty Panels	PET, Perforated Steel, Laminate, Frosted Acrylic	Visit SpecialT.net
Privacy Screens	PET, Frosted Acrylic, Clear Plexiglass	
Grommets	Round or Rectangle	
Power & Data Management	Burele, EZ Power, Ashley Duo Air, Cove, Dean, Nacre, Node, Mho B, Villa, Qi Wireless Charger	
Wire Management	Loop Clips, Velcro Loop, Cable Grip, J-Shape Wire Channel, Snap Wire Channel, Wire Tough, Wire Tray, 1" Wire Channel, Magnetic Channel, Adjustable Spine	
Table Connector	Quick Align	
Chairs	Task, Stacking, Flipper, Sled	
Monitor Arms	Single, Dual, Single Arm with Cross Bar	

\*An Oversize Fee has been implemented by freight carriers for all LTL shipments for pallets 8' and over.  
96"-108" - additional 250.00 | 109" -168" - additional 350.00 | Per custom pallet

TRAINING & TASK TABLES

**Kristina**

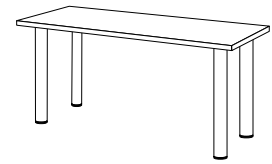

CONFIGURE & PRICE

	MODEL NUMBER	SIZE	CONFIGURE & PRICE		1-DAY	5-DAY
			HPL	WOOD VENEER		
Rectangle	KRST-1824	18 x 24	1,226	1,594	-	1,348
	KRST-1830	18 x 30	1,247	1,680	-	1,371
	KRST-1836	18 x 36	1,261	1,773	-	1,386
	KRST-1842	18 x 42	1,295	1,860	-	1,424
	KRST-1848	18 x 48	1,336	1,994	-	1,469
	KRST-1854	18 x 54	1,352	2,062	-	1,489
	KRST-1860	18 x 60	1,372	2,177	1,179	1,509
	KRST-1866	18 x 66	1,447	2,303	-	1,592
	KRST-1872	18 x 72	1,492	2,442	1,297	1,641
	KRST-1878	18 x 78	2,038	3,039	-	2,241
	KRST-1884	18 x 84	2,170	3,245	-	2,386
	KRST-1896	18 x 96	2,244	3,486	-	2,469
	KRST-2430	24 x 30	1,279	1,832	-	1,406
	KRST-2436	24 x 36	1,309	1,989	-	1,440
	KRST-2442	24 x 42	1,339	2,061	-	1,473
	KRST-2448	24 x 48	1,372	2,213	1,179	1,509
	KRST-2454	24 x 54	1,404	2,312	-	1,545
	KRST-2460	24 x 60	1,433	2,458	1,240	1,577
	KRST-2466	24 x 66	1,535	2,628	-	1,690
	KRST-2472	24 x 72	1,587	2,799	1,393	1,745
	KRST-2478	24 x 78	2,087	3,366	-	2,296
	KRST-2484	24 x 84	2,218	3,589	-	2,440
	KRST-2496	24 x 96	2,325	3,908	-	2,558
	KRST-3042	30 x 42	1,390	2,338	-	1,531
	KRST-3048	30 x 48	1,433	2,539	-	1,577
	KRST-3054	30 x 54	1,484	2,675	-	1,632
	KRST-3060	30 x 60	1,534	2,883	1,340	1,688
	KRST-3066	30 x 66	1,627	3,060	-	1,789
	KRST-3072	30 x 72	1,697	3,287	1,502	1,867
	KRST-3078	30 x 78	2,233	3,911	-	2,458
KRST-3084	30 x 84	2,424	4,267	-	2,666	
KRST-3096	30 x 96	2,511	4,643	-	2,763	

TRAINING & TASK TABLES

**Kristina**

CONFIGURE & PRICE

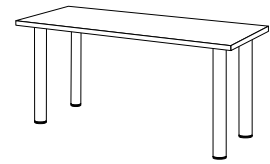

	MODEL NUMBER	SIZE	HPL	WOOD VENEER	1-DAY	5-DAY
Rectangle	KRST-3642	36 x 42	1,489	2,489	-	1,638
	KRST-3648	36 x 48	1,534	2,700	-	1,688
	KRST-3654	36 x 54	1,579	2,836	-	1,737
	KRST-3660	36 x 60	1,654	3,079	-	1,820
	KRST-3666	36 x 66	1,791	3,305	-	1,969
	KRST-3672	36 x 72	1,832	3,511	-	2,015
	KRST-3678	36 x 78	2,425	4,195	-	2,667
	KRST-3684	36 x 84	2,521	4,418	-	2,772
	KRST-3696	36 x 96	2,610	4,803	-	2,870
Round	KRST-24	24"	1,238	1,607	-	-
	KRST-30	30"	1,315	1,882	-	-
	KRST-36	36"	1,414	2,193	-	-
	KRST-42	42"	1,546	2,508	-	-
	KRST-48	48"	1,671	3,002	-	-
Square	KRST-2424	24 x 24	1,214	1,682	-	-
	KRST-3030	30 x 30	1,286	1,948	-	-
	KRST-3636	36 x 36	1,372	2,283	-	-
	KRST-4242	42 x 42	1,492	2,579	-	-
	KRST-4848	48 x 48	1,604	3,099	-	-
Trapezoid	KRST-1848-TRA	18 x 48	1,361	-	-	-
	KRST-1860-TRA	18 x 60	1,402	-	-	-
	KRST-1872-TRA	18 x 72	1,525	-	-	-
	KRST-2448-TRA	24 x 48	1,402	-	-	-
	KRST-2460-TRA	24 x 60	1,469	-	-	-
	KRST-2472-TRA	24 x 72	1,625	-	-	-
	KRST-3048-TRA	30 x 48	1,469	-	-	-
	KRST-3060-TRA	30 x 60	1,577	2,591	-	-
	KRST-3072-TRA	30 x 72	1,741	2,925	-	-
1/2 Round	KRST-3618-HRD	36 x 18	1,366	1,848	-	-
	KRST-4824-HRD	48 x 24	1,502	-	-	-
	KRST-6030-HRD	60 x 30	1,698	2,763	-	-
	KRST-7236-HRD	72 x 36	1,965	3,522	-	-



## TRAINING & TASK TABLES

### Kristina

[CONFIGURE & PRICE](#)

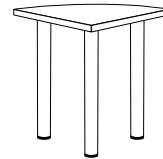

	MODEL NUMBER	SIZE	HPL	WOOD VENEER	1-DAY	5-DAY
1/4 Round	KRST-1818-QRD	18 x 18	1,140	1,330	-	-
	KRST-2424-QRD	24 x 24	1,181	1,573	-	-
	KRST-3030-QRD	30 x 30	1,418	1,997	-	-
	KRST-3636-QRD	36 x 36	1,375	2,165	-	-
Crescent	KRST-1872-CRE	18 x 48 x 72	1,879	-	-	-
	KRST-1894-CRE	18 x 60 x 94	2,853	-	-	-
	KRST-2472-CRE	24 x 48 x 72	1,879	3,011	-	-
	KRST-2494-CRE	24 x 60 x 94	2,853	4,457	-	-
	KRST-3072-CRE	30 x 48 x 72	1,879	3,210	-	-
	KRST-3094-CRE	30 x 60 x 94	2,853	4,620	-	-

### Kristina Options

MODEL NUMBER	DESCRIPTION	ADD-ON	
		4-LEGS	6-LEGS
-CH	Counter Height 36"	164	246
-BH	Bar Height 42"	340	510

### Accessories for Training Tables

OPTION	DESCRIPTION	PRICE
Modesty Panels	PET, Perforated Steel, Laminate, Frosted Acrylic	Visit SpecialT.net
Privacy Screens	PET, Frosted Acrylic, Clear Plexiglass	
Grommets	Round or Rectangle	
Power & Data Management	Burele, EZ Power, Ashley Duo Air, Cove, Dean, Nacre, Node, Mho B, Villa, Qi Wireless Charger	
Wire Management	Loop Clips, Velcro Loop, Cable Grip, J-Shape Wire Channel, Snap Wire Channel, Wire Tough, Wire Tray, 1" Wire Channel, Magnetic Channel, Adjustable Spine	
Table Connector	Quick Align	
Chairs	Task, Stacking, Flipper, Sled	
Monitor Arms	Single, Dual, Single Arm with Cross Bar	

\*An Oversize Fee has been implemented by freight carriers for all LTL shipments for pallets 8' and over.  
96"-108" - additional 250.00 | 109" -168" - additional 350.00 | Per custom pallet

TRAINING & TASK TABLES

**LINK-Stationary**

**CONFIGURE & PRICE**

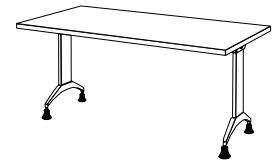

MODEL NUMBER	SIZE	HPL	WOOD VENEER	1-DAY	5-DAY
--------------	------	-----	-------------	-------	-------

**28.75" Height**

Rectangle	LINK-FX-3048	30 x 48	1,281	2,387	-	1,408
	LINK-FX-3060	30 x 60	1,390	2,739	1,281	1,531
	LINK-FX-3072	30 x 72	1,501	3,091	1,317	1,652

**LINK-Stationary Options**

MODEL NUMBER	DESCRIPTION	ADD-ON
-CH	Counter Height 36.75"	33
-BH	Bar Height 40.75"	68
Optional Ganging Clips	4 sets per table	-

**Accessories for Training Tables**

OPTION	DESCRIPTION	PRICE
Modesty Panels	PET, Perforated Steel, Laminate, Frosted Acrylic	Visit SpecialT.net
Privacy Screens	PET, Frosted Acrylic, Clear Plexiglass	
Grommets	Round or Rectangle	
Power & Data Management	Burele, EZ Power, Ashley Duo Air, Cove, Dean, Nacre, Node, Mho B, Villa, Qi Wireless Charger	
Wire Management	Loop Clips, Velcro Loop, Cable Grip, J-Shape Wire Channel, Snap Wire Channel, Wire Tough, Wire Tray, 1" Wire Channel, Magnetic Channel, Adjustable Spine	
Table Connector	Quick Align	
Chairs	Task, Stacking, Flipper, Sled	
Monitor Arms	Single, Dual, Single Arm with Cross Bar	

TRAINING & TASK TABLES

**Portofino-2**

**CONFIGURE & PRICE**

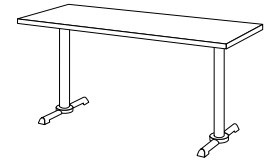

	MODEL NUMBER	SIZE	HPL	WOOD VENEER	1-DAY	5-DAY
Rectangle	PORT2-2442	24 x 42	654	1,376	-	719
	PORT2-2448	24 x 48	692	1,533	497	761
	PORT2-2454	24 x 54	729	1,637	-	802
	PORT2-2460	24 x 60	766	1,791	570	842
	PORT2-2466	24 x 66	885	1,978	-	973
	PORT2-2472	24 x 72	941	2,153	748	1,036
	PORT2-2478	24 x 78	1,048	2,327	-	1,153
	PORT2-2484	24 x 84	1,152	2,523	-	1,268
	PORT2-2496	24 x 96	1,278	2,861	-	1,405
	PORT2-3042	30 x 42	712	1,660	-	785
	PORT2-3048	30 x 48	766	1,872	-	842
	PORT2-3054	30 x 54	812	2,003	-	893
	PORT2-3060	30 x 60	882	2,231	687	970
	PORT2-3066	30 x 66	978	2,411	-	1,078
	PORT2-3072	30 x 72	1,072	2,662	878	1,179
	PORT2-3078	30 x 78	1,232	2,910	-	1,356
	PORT2-3084	30 x 84	1,394	3,237	-	1,533
	PORT2-3096	30 x 96	1,496	3,628	-	1,646

**Portofino-2 Options**

MODEL NUMBER	DESCRIPTION	ADD-ON
-SLG	Self Leveling Glides	84
-BH	Bar Height 42"	196

**Accessories for Training Tables**

OPTION	DESCRIPTION	PRICE
Modesty Panels	PET, Perforated Steel, Laminate, Frosted Acrylic	Visit SpecialT.net
Privacy Screens	PET, Frosted Acrylic, Clear Plexiglass	
Grommets	Round or Rectangle	
Power & Data Management	Burele, EZ Power, Ashley Duo Air, Cove, Dean, Nacre, Node, Mho B, Villa, Qi Wireless Charger	
Wire Management	Loop Clips, Velcro Loop, Cable Grip, J-Shape Wire Channel, Snap Wire Channel, Wire Tough, Wire Tray, 1" Wire Channel, Magnetic Channel, Adjustable Spine	
Table Connector	Quick Align	
Chairs	Task, Stacking, Flipper, Sled	
Monitor Arms	Single, Dual, Single Arm with Cross Bar	

\*An Oversize Fee has been implemented by freight carriers for all LTL shipments for pallets 8' and over.  
96"-108" - additional 250.00 | 109" -168" - additional 350.00 | Per custom pallet

TRAINING & TASK TABLES

**Quatro**

CONFIGURE & PRICE

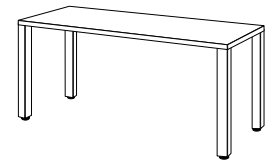

	MODEL NUMBER	SIZE	HPL	WOOD VENEER	1-DAY	5-DAY
	Rectangle	QUAT-1824	18 x 24	796	1,164	-
QUAT-1830		18 x 30	821	1,254	-	902
QUAT-1836		18 x 36	852	1,364	-	937
QUAT-1842		18 x 42	886	1,451	-	975
QUAT-1848		18 x 48	932	1,590	-	1,025
QUAT-1854		18 x 54	956	1,666	-	1,053
QUAT-1860		18 x 60	977	1,782	783	1,075
QUAT-1866		18 x 66	1,066	1,922	-	1,172
QUAT-1872		18 x 72	1,118	2,068	924	1,229
QUAT-1878		18 x 78	1,305	2,306	-	1,435
QUAT-1884		18 x 84	1,438	2,513	-	1,581
QUAT-1896		18 x 96	1,528	2,770	-	1,616
QUAT-2430		24 x 30	868	1,421	-	954
QUAT-2436		24 x 36	899	1,579	-	988
QUAT-2442		24 x 42	939	1,661	-	1,032
QUAT-2448		24 x 48	977	1,818	783	1,075
QUAT-2454		24 x 54	1,014	1,922	-	1,115
QUAT-2460		24 x 60	1,049	2,074	855	1,154
QUAT-2466		24 x 66	1,169	2,262	-	1,286
QUAT-2472		24 x 72	1,229	2,441	1,034	1,352
QUAT-2478		24 x 78	1,534	2,813	-	1,688
QUAT-2484		24 x 84	1,496	2,867	-	1,711
QUAT-2496		24 x 96	1,622	3,205	-	1,785
QUAT-3042		30 x 42	999	1,947	-	1,098
QUAT-3048		30 x 48	1,049	2,155	-	1,154
QUAT-3054		30 x 54	1,108	2,299	-	1,218
QUAT-3060		30 x 60	1,168	2,517	975	1,285
QUAT-3066		30 x 66	1,275	2,708	-	1,402
QUAT-3072		30 x 72	1,359	2,949	1,164	1,494
QUAT-3078		30 x 78	1,577	3,255	-	1,735
QUAT-3084		30 x 84	1,638	3,481	-	1,801
QUAT-3096		30 x 96	1,841	3,973	-	2,024
QUAT-3642	36 x 42	1,111	2,111	-	1,225	
QUAT-3648	36 x 48	1,168	2,334	-	1,285	

TRAINING & TASK TABLES

**Quatro**

CONFIGURE & PRICE

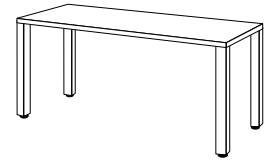

	MODEL NUMBER	SIZE	HPL	WOOD VENEER	1-DAY	5-DAY
Rectangle	QUAT-3654	36 x 54	1,155	2,412	-	1,272
	QUAT-3660	36 x 60	1,309	2,734	-	1,440
	QUAT-3666	36 x 66	1,470	2,984	-	1,616
	QUAT-3672	36 x 72	1,517	3,196	-	1,668
	QUAT-3678	36 x 78	1,712	3,482	-	1,884
	QUAT-3684	36 x 84	1,853	3,750	-	2,038
	QUAT-3696	36 x 96	1,956	4,149	-	2,151
Round	QUAT-24	24"	857	1,226	-	-
	QUAT-30	30"	953	1,520	-	-
	QUAT-36	36"	1,066	1,845	924	-
	QUAT-42	42"	1,220	2,182	1,087	-
	QUAT-48	48"	1,366	2,697	-	-
Square	QUAT-2424	24 x 24	829	1,297	-	-
	QUAT-3030	30 x 30	911	1,573	-	-
	QUAT-3636	36 x 36	1,015	1,926	869	-
	QUAT-4242	42 x 42	1,155	2,242	1,020	-
	QUAT-4848	48 x 48	1,291	2,786	-	-

TRAINING & TASK TABLES

**Quatro**

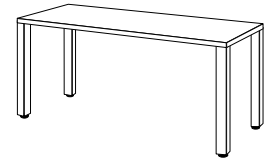

**Quatro Options**

MODEL NUMBER	DESCRIPTION	ADD-ON	
		4-LEG	6-LEG
-CA	Casters	76	114
-BH	Bar Height 42"	252	378
-CUSTHT1	Custom Height between 5" - 28.99"	272	408
-CUSTHT2	Custom Height between 29" - 42"	524	786

**Accessories for Training Tables**

OPTION	DESCRIPTION	PRICE
Modesty Panels	PET, Perforated Steel, Laminate, Frosted Acrylic	Visit SpecialT.net
Privacy Screens	PET, Frosted Acrylic, Clear Plexiglass	
Grommets	Round or Rectangle	
Power & Data Management	Burele, EZ Power, Ashley Duo Air, Cove, Dean, Nacre, Node, Mho B, Villa, Qi Wireless Charger	
Wire Management	Loop Clips, Velcro Loop, Cable Grip, J-Shape Wire Channel, Snap Wire Channel, Wire Tough, Wire Tray, 1" Wire Channel, Magnetic Channel, Adjustable Spine	
Table Connector	Quick Align	
Chairs	Task, Stacking, Flipper, Sled	
Monitor Arms	Single, Dual, Single Arm with Cross Bar	

\*An Oversize Fee has been implemented by freight carriers for all LTL shipments for pallets 8' and over.  
96"-108" - additional 250.00 | 109" -168" - additional 350.00 | Per custom pallet

TRAINING & TASK TABLES

**Robot**

CONFIGURE & PRICE

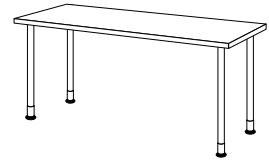

	MODEL NUMBER	SIZE	CONFIGURE & PRICE		1-DAY	5-DAY
			HPL	WOOD VENEER		
Rectangle	ROBT-1824	18 x 24	796	1,164	-	876
	ROBT-1830	18 x 30	821	1,254	-	902
	ROBT-1836	18 x 36	847	1,359	-	933
	ROBT-1842	18 x 42	886	1,451	-	975
	ROBT-1848	18 x 48	932	1,590	-	1,025
	ROBT-1854	18 x 54	956	1,666	-	1,053
	ROBT-1860	18 x 60	977	1,782	783	1,075
	ROBT-1866	18 x 66	1,066	1,922	-	1,172
	ROBT-1872	18 x 72	1,118	2,068	924	1,229
	ROBT-1878	18 x 78	1,247	2,248	-	1,371
	ROBT-1884	18 x 84	1,378	2,453	-	1,515
	ROBT-1896	18 x 96	1,470	2,712	-	1,616
	ROBT-2430	24 x 30	868	1,421	-	954
	ROBT-2436	24 x 36	898	1,578	-	987
	ROBT-2442	24 x 42	939	1,661	-	1,032
	ROBT-2448	24 x 48	977	1,818	783	1,075
	ROBT-2454	24 x 54	1,014	1,922	-	1,115
	ROBT-2460	24 x 60	1,049	2,074	855	1,154
	ROBT-2466	24 x 66	1,169	2,262	-	1,286
	ROBT-2472	24 x 72	1,229	2,441	1,034	1,352
	ROBT-2478	24 x 78	1,335	2,614	-	1,468
	ROBT-2484	24 x 84	1,438	2,809	-	1,581
	ROBT-2496	24 x 96	1,562	3,145	-	1,720
	ROBT-3042	30 x 42	999	1,947	-	1,098
	ROBT-3048	30 x 48	1,049	2,155	-	1,154
	ROBT-3054	30 x 54	1,108	2,299	-	1,218
	ROBT-3060	30 x 60	1,168	2,517	975	1,285
	ROBT-3066	30 x 66	1,275	2,708	-	1,402
	ROBT-3072	30 x 72	1,359	2,949	1,164	1,494
	ROBT-3078	30 x 78	1,518	3,196	-	1,670
ROBT-3084	30 x 84	1,678	3,521	-	1,845	
ROBT-3096	30 x 96	1,781	3,913	-	1,961	
ROBT-3642	36 x 42	1,111	2,111	-	1,225	
ROBT-3648	36 x 48	1,159	2,325	-	1,285	

TRAINING & TASK TABLES

**Robot**

CONFIGURE & PRICE

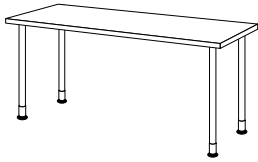

	MODEL NUMBER	SIZE	HPL	WOOD VENEER	1-DAY	5-DAY
Rectangle	ROBT-3654	36 x 54	1,168	2,425	-	1,274
	ROBT-3660	36 x 60	1,309	2,734	-	1,440
	ROBT-3666	36 x 66	1,470	2,984	-	1,616
	ROBT-3672	36 x 72	1,517	3,196	-	1,668
	ROBT-3678	36 x 78	1,654	3,424	-	1,820
	ROBT-3684	36 x 84	1,792	3,689	-	1,973
	ROBT-3696	36 x 96	1,896	4,089	-	2,085
Round	ROBT-24	24"	856	1,225	-	941
	ROBT-30	30"	951	1,518	-	1,047
	ROBT-36	36"	1,066	1,845	-	1,172
	ROBT-42	42"	1,220	2,182	-	1,345
	ROBT-48	48"	1,368	2,699	-	1,505
Square	ROBT-2424	24 x 24	829	1,297	-	911
	ROBT-3030	30 x 30	911	1,573	-	1,001
	ROBT-3636	36 x 36	1,065	1,976	-	1,171
	ROBT-4242	42 x 42	1,220	2,307	-	1,345
	ROBT-4848	48 x 48	1,366	2,861	-	1,502
Trapezoid	ROBT-1848-TRA	18 x 48	962	-	-	-
	ROBT-1860-TRA	18 x 60	1,009	-	-	-
	ROBT-1872-TRA	18 x 72	1,154	-	-	-
	ROBT-2448-TRA	24 x 48	1,009	-	-	-
	ROBT-2460-TRA	24 x 60	1,087	-	-	-
	ROBT-2472-TRA	24 x 72	1,272	-	-	-
	ROBT-3048-TRA	30 x 48	1,087	-	-	-
	ROBT-3060-TRA	30 x 60	1,218	2,232	-	-
ROBT-3072-TRA	30 x 72	1,414	2,598	-	-	
1/2 Round	ROBT-1836-HRD	18 x 36	973	2,248	-	-
	ROBT-2448-HRD	24 x 48	1,131	-	-	-
	ROBT-3060-HRD	30 x 60	1,361	2,426	-	-
	ROBT-3672-HRD	36 x 72	1,677	3,234	-	-
1/4 Round	ROBT-1818-QRD	18 x 18	783	973	-	-
	ROBT-2424-QRD	24 x 24	829	1,221	-	-
	ROBT-3030-QRD	30 x 30	935	1,514	-	-
	ROBT-3636-QRD	36 x 36	1,062	1,852	-	-



## TRAINING & TASK TABLES

### Robot

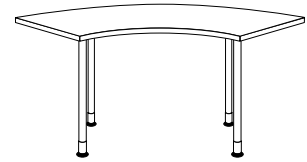

[CONFIGURE & PRICE](#)

	MODEL NUMBER	SIZE	HPL	WOOD VENEER	1-DAY	5-DAY
Crescent	ROBT-1872-CRE	18 x 48 x 72	1,573	-	-	-
	ROBT-1894-CRE	18 x 60 x 94	2,185	-	-	-
	ROBT-2472-CRE	24 x 48 x 72	1,573	2,705	-	-
	ROBT-2494-CRE	24 x 60 x 94	2,185	3,789	-	-
	ROBT-3072-CRE	30 x 48 x 72	1,573	2,904	-	-
	ROBT-3094-CRE	30 x 60 x 94	2,185	3,952	-	-

### Robot Options

MODEL NUMBER	DESCRIPTION	ADD-ON	
		4 LEGS	6 LEGS
-SC	Skate Casters	0	
-AH	Adjustable Height 26" - 36"	128	192
-CUSTHT1	Custom Height between 5" - 28.99"	272	408

### Accessories for Training Tables

OPTION	DESCRIPTION	PRICE
Modesty Panels	PET, Perforated Steel, Laminate, Frosted Acrylic	Visit SpecialT.net
Privacy Screens	PET, Frosted Acrylic, Clear Plexiglass	
Grommets	Round or Rectangle	
Power & Data Management	Burele, EZ Power, Ashley Duo Air, Cove, Dean, Nacre, Node, Mho B, Villa, Qi Wireless Charger	
Wire Management	Loop Clips, Velcro Loop, Cable Grip, J-Shape Wire Channel, Snap Wire Channel, Wire Tough, Wire Tray, 1" Wire Channel, Magnetic Channel, Adjustable Spine	
Table Connector	Quick Align	
Chairs	Task, Stacking, Flipper, Sled	
Monitor Arms	Single, Dual, Single Arm with Cross Bar	

\*An Oversize Fee has been implemented by freight carriers for all LTL shipments for pallets 8' and over.  
96"-108" - additional 250.00 | 109"-168" - additional 350.00 | Per custom pallet

TRAINING & TASK TABLES

**Sienna TL**

CONFIGURE & PRICE

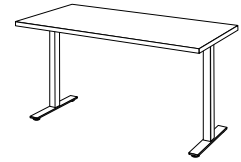

	MODEL NUMBER	SIZE	HPL	WOOD VENEER	1-DAY	5-DAY
Rectangle	SIEN-1TL-2436	24x36	1,061	1,741	-	1,168
	SIEN-1TL-2442	24x42	1,082	1,804	-	1,191
	SIEN-1TL-2448	24x48	1,120	1,961	927	1,232
	SIEN-1TL-2454	24x54	1,232	2,140	-	1,358
	SIEN-1TL-2460	24x60	1,272	2,297	1,080	1,400
	SIEN-1TL-2466	24x66	1,325	2,418	-	1,458
	SIEN-1TL-2472	24x72	1,372	2,584	1,179	1,510
	SIEN-1TL-2484	24x84	1,580	2,951	-	1,738
	SIEN-1TL-3036	30x36	1,094	-	-	1,204
	SIEN-1TL-3042	30x42	1,141	2,089	-	1,256
	SIEN-1TL-3048	30x48	1,194	2,300	-	1,314
	SIEN-1TL-3054	30x54	1,331	2,522	-	1,465
	SIEN-1TL-3060	30x60	1,388	2,737	1,193	1,527
	SIEN-1TL-3066	30x66	1,430	2,863	-	1,575
	SIEN-1TL-3072	30x72	1,502	3,092	1,309	1,653
	SIEN-1TL-3084	30x84	1,818	3,661	-	2,000
	SIEN-1TL-3648	36x48	1,311	2,477	-	1,443
	SIEN-1TL-3654	36x54	1,444	2,701	-	1,589
	SIEN-1TL-3660	36x60	1,532	2,957	-	1,686
	SIEN-1TL-3666	36x66	1,622	3,136	-	1,785
SIEN-1TL-3672	36x72	1,658	3,337	-	1,824	
SIEN-1TL-3684	36x84	1,820	3,590	-	2,002	

**Sienna TL Options**

MODEL NUMBER	DESCRIPTION	ADD-ON
-TL	T-Leg Option	-
-CL	C-Leg Option	-
-SC	Skate Casters	126
-BH	Bar Height 42"	128
-CUSTHT1	Custom Height between 5" - 28.99"	136
-CUSTHT2	Custom Height between 29" - 42"	262

**Accessories for Training Tables**

OPTION	DESCRIPTION	PRICE
Modesty Panels	PET, Perforated Steel, Laminate, Frosted Acrylic	Visit SpecialT.net
Privacy Screens	PET, Frosted Acrylic, Clear Plexiglass	
Grommets	Round or Rectangle	
Power & Data Management	Burele, EZ Power, Ashley Duo Air, Cove, Dean, Nacre, Node, Mho B, Villa, Qi Wireless Charger	
Wire Management	Loop Clips, Velcro Loop, Cable Grip, J-Shape Wire Channel, Snap Wire Channel, Wire Tough, Wire Tray, 1" Wire Channel, Magnetic Channel, Adjustable Spine	
Table Connector	Quick Align	
Chairs	Task, Stacking, Flipper, Sled	
Monitor Arms	Single, Dual, Single Arm with Cross Bar	

TRAINING & TASK TABLES

**Structure 2TL**

CONFIGURE & PRICE

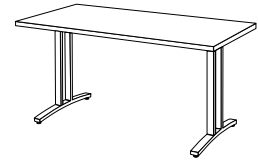

	MODEL NUMBER	SIZE	HPL	WOOD VENEER	1-DAY	5-DAY
Rectangle	STRU-2T-1848	18 x 48*	1,065	1,723	-	1,171
	STRU-2T-1860	18 x 60*	1,182	1,987	988	1,301
	STRU-2T-1872	18 x 72*	1,272	2,222	1,080	1,400
	STRU-2T-2436	24 x 36	1,071	1,751	-	1,177
	STRU-2T-2442	24 x 42	1,110	1,832	-	1,223
	STRU-2T-2448	24 x 48	1,154	1,995	961	1,271
	STRU-2T-2454	24 x 54	1,218	2,126	-	1,339
	STRU-2T-2460	24 x 60	1,313	2,338	1,119	1,445
	STRU-2T-2466	24 x 66	1,394	2,487	-	1,533
	STRU-2T-2472	24 x 72	1,493	2,705	1,298	1,643
	STRU-2T-3036	30 x 36	1,096	-	-	1,206
	STRU-2T-3042	30 x 42	1,159	2,107	-	1,274
	STRU-2T-3048	30 x 48	1,213	2,319	-	1,334
	STRU-2T-3054	30 x 54	1,279	2,470	-	1,406
	STRU-2T-3060	30 x 60	1,360	2,709	1,165	1,496
	STRU-2T-3066	30 x 66	1,457	2,890	-	1,602
STRU-2T-3072	30 x 72	1,555	3,145	1,361	1,711	

**Structure 2TL Options**

MODEL NUMBER	DESCRIPTION	ADD-ON
-CA	Casters	72

**Accessories for Training Tables**

OPTION	DESCRIPTION	PRICE
Modesty Panels	PET, Perforated Steel, Laminate, Frosted Acrylic	Visit SpecialT.net
Privacy Screens	PET, Frosted Acrylic, Clear Plexiglass	
Grommets	Round or Rectangle	
Power & Data Management	Burele, EZ Power, Ashley Duo Air, Cove, Dean, Nacre, Node, Mho B, Villa, Qi Wireless Charger	
Wire Management	Loop Clips, Velcro Loop, Cable Grip, J-Shape Wire Channel, Snap Wire Channel, Wire Tough, Wire Tray, 1" Wire Channel, Magnetic Channel, Adjustable Spine	
Table Connector	Quick Align	
Chairs	Task, Stacking, Flipper, Sled	
Monitor Arms	Single, Dual, Single Arm with Cross Bar	

TRAINING & TASK TABLES

**Structure 2CL**

**CONFIGURE & PRICE**

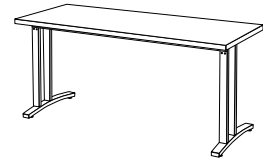

	MODEL NUMBER	SIZE	HPL	WOOD VENEER	1-DAY	5-DAY
Rectangle	STRU-2C-2436	24 x 36	1,065	1,745	-	1,171
	STRU-2C-2442	24 x 42	1,110	1,832	-	1,223
	STRU-2C-2448	24 x 48	1,154	1,995	961	1,271
	STRU-2C-2454	24 x 54	1,218	2,126	-	1,339
	STRU-2C-2460	24 x 60	1,313	2,338	1,119	1,445
	STRU-2C-2466	24 x 66	1,394	2,487	-	1,533
	STRU-2C-2472	24 x 72	1,493	2,705	1,298	1,643
	STRU-2C-3036	30 x 36	1,096	-	-	1,206
	STRU-2C-3042	30 x 42	1,159	2,107	-	1,274
	STRU-2C-3048	30 x 48	1,213	2,319	-	1,334
	STRU-2C-3054	30 x 54	1,279	2,470	-	1,406
	STRU-2C-3060	30 x 60	1,360	2,709	1,165	1,496
	STRU-2C-3066	30 x 66	1,457	2,890	-	1,602
	STRU-2C-3072	30 x 72	1,555	3,145	1,361	1,711

**Structure 2CL Options**

MODEL NUMBER	DESCRIPTION	ADD-ON
-CA	Casters	72

**Accessories for Training Tables**

OPTION	DESCRIPTION	PRICE
Modesty Panels	PET, Perforated Steel, Laminate, Frosted Acrylic	Visit SpecialT.net
Privacy Screens	PET, Frosted Acrylic, Clear Plexiglass	
Grommets	Round or Rectangle	
Power & Data Management	Burele, EZ Power, Ashley Duo Air, Cove, Dean, Nacre, Node, Mho B, Villa, Qi Wireless Charger	
Wire Management	Loop Clips, Velcro Loop, Cable Grip, J-Shape Wire Channel, Snap Wire Channel, Wire Tough, Wire Tray, 1" Wire Channel, Magnetic Channel, Adjustable Spine	
Table Connector	Quick Align	
Chairs	Task, Stacking, Flipper, Sled	
Monitor Arms	Single, Dual, Single Arm with Cross Bar	

TRAINING & TASK TABLES

**Structure H**

**CONFIGURE & PRICE**



	MODEL NUMBER	SIZE	HPL	WOOD VENEER	1-DAY	5-DAY
Rectangle	STRU-H-2436	24 x 36	1,074	1,754	-	1,182
	STRU-H-2442	24 x 42	1,095	1,817	-	1,205
	STRU-H-2448	24 x 48	1,136	1,977	941	1,249
	STRU-H-2454	24 x 54	1,175	2,083	-	1,292
	STRU-H-2460	24 x 60	1,295	2,320	1,102	1,424
	STRU-H-2466	24 x 66	1,347	2,440	-	1,482
	STRU-H-2472	24 x 72	1,397	2,609	1,204	1,537
	STRU-H-3036	30 x 36	1,166	-	-	1,284
	STRU-H-3042	30 x 42	1,218	2,166	-	1,339
	STRU-H-3048	30 x 48	1,273	2,379	-	1,401
	STRU-H-3054	30 x 54	1,339	2,530	-	1,473
	STRU-H-3060	30 x 60	1,471	2,820	1,278	1,619
	STRU-H-3066	30 x 66	1,520	2,953	-	1,671
	STRU-H-3072	30 x 72	1,591	3,181	1,397	1,751

**Accessories for Training Tables**

OPTION	DESCRIPTION	PRICE
Modesty Panels	PET, Perforated Steel, Laminate, Frosted Acrylic	Visit SpecialT.net
Privacy Screens	PET, Frosted Acrylic, Clear Plexiglass	
Grommets	Round or Rectangle	
Power & Data Management	Burele, EZ Power, Ashley Duo Air, Cove, Dean, Nacre, Node, Mho B, Villa, Qi Wireless Charger	
Wire Management	Loop Clips, Velcro Loop, Cable Grip, J-Shape Wire Channel, Snap Wire Channel, Wire Tough, Wire Tray, 1" Wire Channel, Magnetic Channel, Adjustable Spine	
Table Connector	Quick Align	
Chairs	Task, Stacking, Flipper, Sled	
Monitor Arms	Single, Dual, Single Arm with Cross Bar	

TRAINING & TASK TABLES

# Structure Square

**CONFIGURE & PRICE**

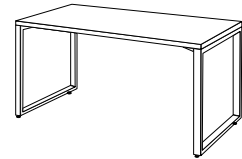

	MODEL NUMBER	SIZE	HPL	WOOD VENEER	1-DAY	5-DAY
Rectangle	STRU-SQ-2436	24 x 36	1,133	1,813	-	1,247
	STRU-SQ-2442	24 x 42	1,155	1,877	-	1,272
	STRU-SQ-2448	24 x 48	1,195	2,036	1,003	1,315
	STRU-SQ-2454	24 x 54	1,238	2,146	-	1,361
	STRU-SQ-2460	24 x 60	1,353	2,378	1,162	1,491
	STRU-SQ-2466	24 x 66	1,408	2,501	-	1,550
	STRU-SQ-2472	24 x 72	1,456	2,668	1,262	1,601
	STRU-SQ-3036	30 x 36	1,226	-	-	1,348
	STRU-SQ-3042	30 x 42	1,279	2,227	-	1,406
	STRU-SQ-3048	30 x 48	1,335	2,441	-	1,468
	STRU-SQ-3054	30 x 54	1,400	2,591	-	1,539
	STRU-SQ-3060	30 x 60	1,533	2,882	1,339	1,686
	STRU-SQ-3066	30 x 66	1,578	3,011	-	1,736
	STRU-SQ-3072	30 x 72	1,653	3,243	1,458	1,819

## Accessories for Training Tables

OPTION	DESCRIPTION	PRICE
Modesty Panels	PET, Perforated Steel, Laminate, Frosted Acrylic	Visit SpecialT.net
Privacy Screens	PET, Frosted Acrylic, Clear Plexiglass	
Grommets	Round or Rectangle	
Power & Data Management	Burele, EZ Power, Ashley Duo Air, Cove, Dean, Nacre, Node, Mho B, Villa, Qi Wireless Charger	
Wire Management	Loop Clips, Velcro Loop, Cable Grip, J-Shape Wire Channel, Snap Wire Channel, Wire Tough, Wire Tray, 1" Wire Channel, Magnetic Channel, Adjustable Spine	
Table Connector	Quick Align	
Chairs	Task, Stacking, Flipper, Sled	
Monitor Arms	Single, Dual, Single Arm with Cross Bar	

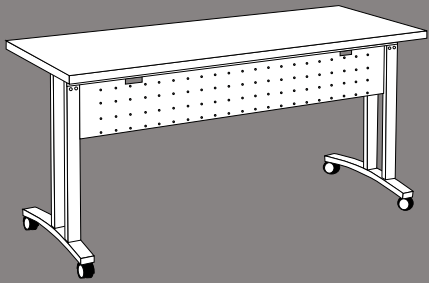

## FLIP & NEST TABLES

FLIP & NEST TABLES

**Convertible**

CONFIGURE & PRICE



	MODEL NUMBER	SIZE	HPL	WOOD VENEER	1-DAY	5-DAY
Rectangle	CONV-1848	18 x 48	1,474	2,132	-	1,624
	CONV-1854	18 x 54	1,510	2,220	-	1,660
	CONV-1860	18 x 60	1,554	2,359	1,360	1,709
	CONV-1866	18 x 66	1,587	2,443	-	1,745
	CONV-1872	18 x 72	1,639	2,589	1,446	1,804
	CONV-2448	24 x 48	1,554	2,395	1,360	1,709
	CONV-2454	24 x 54	1,602	2,510	-	1,762
	CONV-2460	24 x 60	1,660	2,685	1,468	1,828
	CONV-2466	24 x 66	1,725	2,818	-	1,898
	CONV-2472	24 x 72	1,789	3,001	1,594	1,967
	CONV-3048	30 x 48	1,660	2,766	-	1,828
	CONV-3054	30 x 54	1,732	2,923	-	1,905
	CONV-3060	30 x 60	1,815	3,164	1,622	1,998
	CONV-3066	30 x 66	1,886	3,319	-	2,076
	CONV-3072	30 x 72	1,957	3,547	1,730	2,152

**Accessories for Flip & Nest Tables**

OPTION	DESCRIPTION	PRICE
Modesty Panels	PET, Laminate, Frosted Acrylic	Visit SpecialT.net
Grommets	Round or Rectangle	
Power & Data Management	Burele, EZ Power, Ashley Duo Air, Cove, Dean, Nacre, Node, Mo B, Villa, Qi Wireless Charger	
Wire Management	Loop Clips, Velcro Loop, Cable Grip, J-Shape Wire Channel, Snap Wire Channel	
Table Connector	Quick Align	
Chairs	Task, Stacking, Flipper, Sled	



FLIP & NEST TABLES

**Kingston Flip Arched**

**CONFIGURE & PRICE**

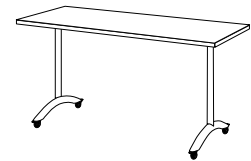

	MODEL NUMBER	SIZE	HPL	WOOD VENEER	1-DAY	5-DAY
Rectangle	KINGFLIP-ATL-2448	24 x 48	1,494	2,335	1,308	1,631
	KINGFLIP-ATL-2460	24 x 60	1,589	2,614	1,404	1,734
	KINGFLIP-ATL-2472	24 x 72	1,704	2,916	1,516	1,861
	KINGFLIP-ATL-3048	30 x 48	1,565	2,671	-	1,708
	KINGFLIP-ATL-3060	30 x 60	1,704	3,053	1,516	1,861
	KINGFLIP-ATL-3072	30 x 72	1,828	3,418	1,641	1,996

**Accessories for Flip & Nest Tables**

OPTION	DESCRIPTION	PRICE
Modesty Panels	PET, Laminate, Frosted Acrylic	Visit SpecialT.net
Grommets	Round or Rectangle	
Power & Data Management	Burele, EZ Power, Ashley Duo Air, Cove, Dean, Nacre, Node, Mo B, Villa, Qi Wireless Charger	
Wire Management	Loop Clips, Velcro Loop, Cable Grip, J-Shape Wire Channel, Snap Wire Channel	
Table Connector	Quick Align	
Chairs	Task, Stacking, Flipper, Sled	

FLIP & NEST TABLES

**Kingston Flip**

CONFIGURE & PRICE

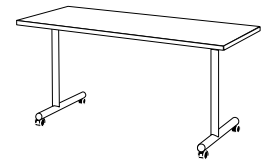

	MODEL NUMBER	SIZE	HPL	WOOD VENEER	1-DAY	5-DAY
Rectangle	KINGFLIP-1848	18 x 48	1,312	1,970	-	1,444
	KINGFLIP-1854	18 x 54	1,344	2,054	-	1,478
	KINGFLIP-1860	18 x 60	1,375	2,180	1,190	1,513
	KINGFLIP-1866	18 x 66	1,404	2,260	-	1,544
	KINGFLIP-1872	18 x 72	1,452	2,402	1,267	1,599
	KINGFLIP-1884	18 x 84	1,556	2,631	-	1,712
	KINGFLIP-2448	24 x 48	1,352	2,193	1,166	1,489
	KINGFLIP-2454	24 x 54	1,402	2,310	-	1,543
	KINGFLIP-2460	24 x 60	1,447	2,472	1,262	1,592
	KINGFLIP-2466	24 x 66	1,505	2,598	-	1,656
	KINGFLIP-2472	24 x 72	1,562	2,774	1,374	1,719
	KINGFLIP-2484	24 x 84	1,685	3,056	-	1,853
	KINGFLIP-3048	30 x 48	1,423	2,529	-	1,566
	KINGFLIP-3054	30 x 54	1,493	2,684	-	1,643
	KINGFLIP-3060	30 x 60	1,562	2,911	1,374	1,719
	KINGFLIP-3066	30 x 66	1,626	3,059	-	1,787
KINGFLIP-3072	30 x 72	1,686	3,276	1,499	1,854	
KINGFLIP-3084	30 x 84	1,825	3,668	-	2,007	

**Accessories for Flip & Nest Tables**

OPTION	DESCRIPTION	PRICE
Modesty Panels	PET, Laminate, Frosted Acrylic	Visit SpecialT.net
Grommets	Round or Rectangle	
Power & Data Management	Burele, EZ Power, Ashley Duo Air, Cove, Dean, Nacre, Node, Mo B, Villa, Qi Wireless Charger	
Wire Management	Loop Clips, Velcro Loop, Cable Grip, J-Shape Wire Channel, Snap Wire Channel	
Table Connector	Quick Align	
Chairs	Task, Stacking, Flipper, Sled	

FLIP & NEST TABLES  
**Kingston Flip-C**

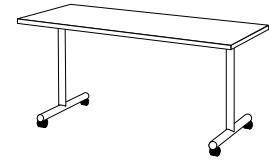

CONFIGURE & PRICE

	MODEL NUMBER	SIZE	HPL	WOOD VENEER	1-DAY	5-DAY
Rectangle	KINGFLIP-C-1848	18 x 48	1,312	1,970	-	1,444
	KINGFLIP-C-1860	18 x 60	1,375	2,180	1,190	1,513
	KINGFLIP-C-1872	18 x 72	1,452	2,402	1,267	1,599
	KINGFLIP-C-2448	24 x 48	1,352	2,193	1,166	1,489
	KINGFLIP-C-2460	24 x 60	1,447	2,472	1,262	1,592
	KINGFLIP-C-2472	24 x 72	1,562	2,774	1,374	1,719
	KINGFLIP-C-3048	30 x 48	1,423	2,529	1,257	1,566
	KINGFLIP-C-3060	30 x 60	1,562	2,911	1,382	1,719
	KINGFLIP-C-3072	30 x 72	1,686	3,276	-	1,854

**Accessories for Flip & Nest Tables**

OPTION	DESCRIPTION	PRICE
Modesty Panels	PET, Laminate, Frosted Acrylic	Visit SpecialT.net
Grommets	Round or Rectangle	
Power & Data Management	Burele, EZ Power, Ashley Duo Air, Cove, Dean, Nacre, Node, Mo B, Villa, Qi Wireless Charger	
Wire Management	Loop Clips, Velcro Loop, Cable Grip, J-Shape Wire Channel, Snap Wire Channel	
Table Connector	Quick Align	
Chairs	Task, Stacking, Flipper, Sled	

FLIP & NEST TABLES

**LINK**

CONFIGURE & PRICE

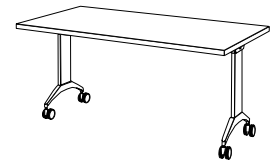

	MODEL NUMBER	SIZE	HPL	WOOD VENEER	1-DAY	5-DAY
Rectangle	LINK-2436	24 x 36	1,273	1,953	-	1,401
	LINK-2442	24 x 42	1,384	2,106	-	1,522
	LINK-2448	24 x 48	1,413	2,254	1,240	1,554
	LINK-2454	24 x 54	1,485	2,393	-	1,635
	LINK-2460	24 x 60	1,501	2,526	1,311	1,652
	LINK-2466	24 x 66	1,594	2,687	-	1,755
	LINK-2472	24 x 72	1,639	2,851	1,465	1,804
	LINK-2478	24 x 78	1,771	3,050	-	1,950
	LINK-3042	30 x 42	1,443	2,391	-	1,587
	LINK-3048	30 x 48	1,501	2,607	-	1,652
	LINK-3054	30 x 54	1,580	2,771	-	1,738
	LINK-3060	30 x 60	1,625	2,974	1,424	1,788
	LINK-3066	30 x 66	1,726	3,159	-	1,900
	LINK-3072	30 x 72	1,808	3,398	1,575	1,989
	LINK-3078	30 x 78	1,925	3,603	-	2,119
	LINK-3648	36 x 48	1,594	2,760	-	1,755
	LINK-3654	36 x 54	1,712	2,969	-	1,884
	LINK-3660	36 x 60	1,749	3,174	-	1,924
	LINK-3666	36 x 66	1,867	3,381	-	2,053
	LINK-3672	36 x 72	1,925	3,604	-	2,119
LINK-3678	36 x 78	2,019	3,789	-	2,222	
Trapezoid	LINK-3060-TRA	30 x 60	1,859	2,873	-	-
	LINK-3072-TRA	30 x 72	2,098	3,282	-	-
	LINK-3672-TRA	36 x 72	2,130	3,405	-	-
1/2 Round	LINK-3060-HRD	30 x 60	1,721	2,786	-	-
	LINK-3672-HRD	36 x 72	1,867	3,424	-	-
Crescent	LINK-2448-CRE	24 x 48 x 75	2,415	3,547	-	-
	LINK-2460-CRE	24 x 60 x 94	2,584	4,188	-	-
	LINK-3048-CRE	30 x 48 x 75	2,617	3,948	-	-
	LINK-3060-CRE	30 x 60 x 94	2,745	4,512	-	-
1/4 Round	LINK-2424-QRD	24 x 24	658	1,050	-	-
	LINK-3030-QRD	30 x 30	768	1,347	-	-
Presentation	LINK-2449-PRE	24 x 49	1,625	2,208	-	-
	LINK-3061-PRE	30 x 61	1,896	2,593	-	-

FLIP & NEST TABLES

**LINK**

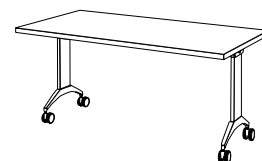

**Accessories for Flip & Nest Tables**

OPTION	DESCRIPTION	PRICE
Modesty Panels	PET, Laminate, Frosted Acrylic	Visit SpecialT.net
Grommets	Round or Rectangle	
Power & Data Management	Burele, EZ Power, Ashley Duo Air, Cove, Dean, Nacre, Node, Mo B, Villa, Qi Wireless Charger	
Wire Management	Loop Clips, Velcro Loop, Cable Grip, J-Shape Wire Channel, Snap Wire Channel, 1" Wire Channel	
Table Connector	LINK Connector	
Chairs	Task, Stacking, Flipper, Sled	

FLIP & NEST TABLES

# Structure Flip Top T

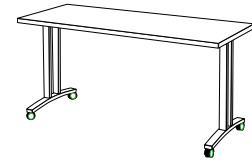

**CONFIGURE & PRICE**

MODEL NUMBER	SIZE	HPL	WOOD VENEER	1-DAY	5-DAY	
<b>Without Modesty Panel</b>						
Rectangle	STRU-FT-T-2448	24 x 48	1,654	2,495	1,459	1,820
	STRU-FT-T-2460	24 x 60	1,735	2,760	1,542	1,908
	STRU-FT-T-2472	24 x 72	1,815	3,027	1,622	1,998
	STRU-FT-T-3048	30 x 48	1,753	2,859	-	1,930
	STRU-FT-T-3060	30 x 60	1,906	3,255	1,710	2,096
	STRU-FT-T-3072	30 x 72	2,017	3,607	1,793	2,219
	STRU-FT-T-3648	36 x 48	1,857	3,023	-	2,043
	STRU-FT-T-3660	36 x 60	2,027	3,452	-	2,229
	STRU-FT-T-3672	36 x 72	2,156	3,835	-	2,372
Round	STRU-FT-T-60	60"	3,116	5,095	-	3,427

## Accessories for Flip & Nest Tables

OPTION	DESCRIPTION	PRICE
Modesty Panels	PET, Laminate, Frosted Acrylic	Visit SpecialT.net
Grommets	Round or Rectangle	
Power & Data Management	Burele, EZ Power, Ashley Duo Air, Cove, Dean, Nacre, Node, Mo B, Villa, Qi Wireless Charger	
Wire Management	Loop Clips, Velcro Loop, Cable Grip, J-Shape Wire Channel, Snap Wire Channel	
Table Connector	Quick Align	
Chairs	Task, Stacking, Flipper, Sled	

FLIP & NEST TABLES

**Structure Flip Top C**

CONFIGURE & PRICE

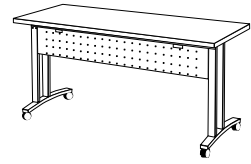

MODEL NUMBER	SIZE	HPL	WOOD VENEER	1-DAY	5-DAY
--------------	------	-----	-------------	-------	-------

**With Built-in Steel Modesty Panel**

Rectangle	MODEL NUMBER	SIZE	HPL	WOOD VENEER	1-DAY	5-DAY
	STRU-FT-C-2448	24 x 48	1,824	2,665	1,630	2,006
	STRU-FT-C-2460	24 x 60	1,944	2,969	1,733	2,138
	STRU-FT-C-2472	24 x 72	2,078	3,290	1,838	2,287
	STRU-FT-C-3048	30 x 48	1,897	3,003	-	2,087
	STRU-FT-C-3060	30 x 60	2,114	3,463	1,1878	2,326
	STRU-FT-C-3072	30 x 72	2,334	3,924	2,065	2,567

**Accessories for Flip & Nest Tables**

OPTION	DESCRIPTION	PRICE
Modesty Panels	PET, Laminate, Frosted Acrylic	Visit SpecialT.net
Grommets	Round or Rectangle	
Power & Data Management	Burele, EZ Power, Ashley Duo Air, Cove, Dean, Nacre, Node, Mo B, Villa, Qi Wireless Charger	
Wire Management	Loop Clips, Velcro Loop, Cable Grip, J-Shape Wire Channel, Snap Wire Channel	
Table Connector	Quick Align	
Chairs	Task, Stacking, Flipper, Sled	

FLIP & NEST TABLES

## Transform 2

[CONFIGURE & PRICE](#)

MODEL NUMBER	SIZE	HPL	WOOD VENEER	1-DAY	5-DAY
--------------	------	-----	-------------	-------	-------

**With Built-in Steel Modesty Panel**

Rectangle	MODEL NUMBER	SIZE	HPL	WOOD VENEER	1-DAY	5-DAY
	TRNF2-1848	18 x 48	950	1,608	-	1,045
	TRNF2-1860	18 x 60	1,038	1,843	844	1,141
	TRNF2-1872	18 x 72	1,154	2,104	962	1,271
	TRNF2-2448	24 x 48	1,008	1,849	816	1,109
	TRNF2-2460	24 x 60	1,096	2,121	902	1,206
	TRNF2-2472	24 x 72	1,176	2,388	983	1,295

### Accessories for Flip & Nest Tables

OPTION	DESCRIPTION	PRICE
Modesty Panels	PET, Laminate, Frosted Acrylic	Visit SpecialT.net
Grommets	Round or Rectangle	
Power & Data Management	Burele, EZ Power, Ashley Duo Air, Cove, Dean, Nacre, Node, Mo B, Villa, Qi Wireless Charger	
Wire Management	Loop Clips, Velcro Loop, Cable Grip, J-Shape Wire Channel, Snap Wire Channel	
Table Connector	Quick Align	
Chairs	Task, Stacking, Flipper, Sled	



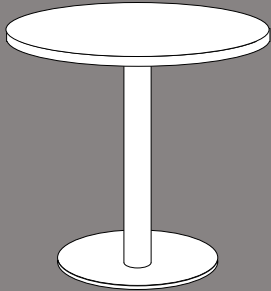

BREAKROOM  
& CAFÉ TABLES

## BREAKROOM & CAFÉ TABLES

### Bedford

CONFIGURE & PRICE



	MODEL NUMBER	SIZE	HPL	WOOD VENEER	1-DAY	5-DAY
Round	BDFD-42	42"	1,341	2,303	1,148	1,478
	BDFD-48	48"	1,495	2,826	-	1,646
	BDFD-54	54"	1,938	3,452	-	2,131
	BDFD-60	60"	1,985	3,964	-	2,183
	BDFD-66	66"	2,096	4,804	-	2,305
	BDFD-72	72"	3,215	6,438	-	3,537
Square	BDFD-4242	42 x 42	1,285	2,372	1,092	1,414
	BDFD-4848	48 x 48	1,440	2,935	-	1,586
	BDFD-5454	54 x 54	1,680	3,399	-	1,850
	BDFD-6060	60 x 60	1,883	4,102	-	2,072

### Bedford Options

MODEL NUMBER	DESCRIPTION	ADD-ON
-CA	Castors	76
-SLG	Self Leveling Glides	84
-BH	Bar Height 42"	252
-CUSTHT1	Custom Height between 5" - 29" *	272
-CUSTHT2	Custom Height between 29" - 42" *	524

\* Not available for 66" and 72" tables

### Accessories for Breakroom & Café Tables

OPTION	DESCRIPTION	PRICE
Power & Data Management	Burele, EZ Power, Interact G2, Cove, Oasis, Stafford, Villa, Qi Wireless Charger	Visit SpecialT.net
Wire Management	Loop Clips, Velcro Loop, Cable Grip, J-shape Wire Channel, Snap Wire Channel, 1" Wire Channel, Metal Snap-On, Leg Clip	
Chairs	Task, Stacking, Flipper, Sled	

## BREAKROOM & CAFÉ TABLES

### Bistro

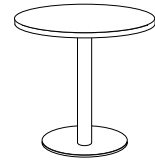

CONFIGURE & PRICE

	MODEL NUMBER	SIZE	HPL	WOOD VENEER	1-DAY	5-DAY
Round	BSTR-24	24"	857	1,226	-	945
	BSTR-30	30"	935	1,502	-	1,030
	BSTR-36	36"	1,205	1,984	1,012	1,327
Square	BSTR-2424	24 x 24	832	1,300	-	915
	BSTR-3030	30 x 30	905	1,567	-	995
	BSTR-3636	36 x 36	1,164	2,075	972	1,280

### Bistro Options

MODEL NUMBER	DESCRIPTION	ADD-ON
-BH	Bar Height 42"	85

### Accessories for Breakroom & Café Tables

OPTION	DESCRIPTION	PRICE
Power & Data Management	Burele, EZ Power, Interact G2, Cove, Oasis, Stafford, Villa, Qi Wireless Charger	Visit SpecialT.net
Wire Management	Loop Clips, Velcro Loop, Cable Grip, J-shape Wire Channel, Snap Wire Channel, 1" Wire Channel, Metal Snap-On, Leg Clip	
Chairs	Task, Stacking, Flipper, Sled	

## BREAKROOM & CAFÉ TABLES

### Cantina-2

CONFIGURE & PRICE



	MODEL NUMBER	SIZE	HPL	WOOD VENEER	1-DAY	5-DAY
Round	CTNA2-24	24"	564	933	-	622
	CTNA2-30	30"	657	1,224	-	723
	CTNA2-36	36"	862	1,641	668	948
	CTNA2-42	42"	1,128	2,090	934	1,241
	CTNA2-48	48"	1,274	2,605	-	1,402
	CTNA2-54	54"	1,392	2,906	-	1,532
Square	CTNA2-2424	24 x 24	533	1,001	-	587
	CTNA2-3030	30 x 30	620	1,282	-	684
	CTNA2-3636	36 x 36	814	1,725	620	894
	CTNA2-4242	42 x 42	1,065	2,152	873	1,172
	CTNA2-4848	48 x 48	1,198	2,693	-	1,317
	CTNA2-5454	54 x 54	1,345	3,064	-	1,478

### Cantina-2 Options

MODEL NUMBER	DESCRIPTION	ADD-ON
-BH	Bar Height 42"	98
-FR*	Foot Ring	104
-SLG	Self Leveling Glides for 24" and 30" tables	84
-SLG	Self Leveling Glides for 36" and 54" tables	105

\* Available only with Bar Height option

### Accessories for Breakroom & Café Tables

OPTION	DESCRIPTION	PRICE
Power & Data Management	Burele, EZ Power, Interact G2, Cove, Oasis, Stafford, Villa, Qi Wireless Charger	Visit SpecialT.net
Wire Management	Loop Clips, Velcro Loop, Cable Grip, J-shape Wire Channel, Snap Wire Channel, 1" Wire Channel, Metal Snap-On, Leg Clip	
Chairs	Task, Stacking, Flipper, Sled	

BREAKROOM & CAFÉ TABLES

**ClassiX**

CONFIGURE & PRICE



	MODEL NUMBER	SIZE	HPL	WOOD VENEER	1-DAY	5-DAY
Round	CLSX-24	24"	638	1,007	-	703
	CLSX-30	30"	732	1,299	-	805
	CLSX-36	36"	845	1,624	658	930
	CLSX-42	42"	1,000	1,962	816	1,103
	CLSX-48	48"	1,151	2,482	-	1,267
Square	CLSX-2424	24 x 24	610	1,078	-	669
	CLSX-3030	30 x 30	697	1,359	-	766
	CLSX-3636	36 x 36	799	1,710	612	878
	CLSX-4242	42 x 42	942	2,029	755	1,037
	CLSX-4848	48 x 48	1,077	2,572	-	1,184
Rectangle	CLSX-2430	24 x 30	697	1,250	-	766
	CLSX-2436	24 x 36	799	1,479	-	878
	CLSX-2442	24 x 42	941	1,663	-	1,037
	CLSX-2448	24 x 48	1,077	1,918	890	1,184
	CLSX-3036	30 x 36	799	-	-	878
	CLSX-3042	30 x 42	966	1,914	-	1,065
	CLSX-3048	30 x 48	1,124	2,230	-	-
	CLSX-3642	36 x 42	1,095	2,095	-	1,204
	CLSX-3648	36 x 48	1,205	2,371	-	1,377
	CLSX-4248	42 x 48	1,252	-	-	1,326

**ClassiX Options**

MODEL NUMBER	DESCRIPTION	ADD-ON
-BH	Bar Height 42"	63
-FT	Flip Top - Quick Flip (Select sizes only)	240
-CA	Castors	76
-SLG	Self Leveling Glides	84
-CUSTHT1	Custom Height between 5" - 28.99"	68
-CUSTHT2	Custom Height between 29" - 42"	131

**Accessories for Breakroom & Café Tables**

OPTION	DESCRIPTION	PRICE
Power & Data Management	Burele, EZ Power, Interact G2, Cove, Oasis, Stafford, Villa, Qi Wireless Charger	Visit SpecialT.net
Wire Management	Loop Clips, Velcro Loop, Cable Grip, J-shape Wire Channel, Snap Wire Channel, 1" Wire Channel, Metal Snap-On, Leg Clip	
Chairs	Task, Stacking, Flipper, Sled	

BREAKROOM & CAFÉ TABLES

**Floor Mounted**

CONFIGURE & PRICE



	MODEL NUMBER	SIZE	HPL	WOOD VENEER	1-DAY	5-DAY
Round	FLOOR-24	24"	574	943	-	631
	FLOOR-30	30"	648	1,215	-	714
	FLOOR-36	36"	715	1,494	522	788
Square	FLOOR-2424	24 x 24	537	1,005	-	591
	FLOOR-3030	30 x 30	614	1,276	-	676
	FLOOR-3636	36 x 36	726	1,637	534	800
Rectangle	FLOOR-2430-RT	24 x 30	570	1,123	-	627
	FLOOR-2436-RT	24 x 36	602	1,282	-	662
	FLOOR-2442-RT	24 x 42	621	1,343	-	684
	FLOOR-2448-RT	24 x 48	839	1,680	644	922
	FLOOR-2454-RT	24 x 54	873	1,781	-	961
	FLOOR-2460-RT	24 x 60	910	1,935	715	1,000
	FLOOR-2466-RT	24 x 66	964	2,057	-	1,061
	FLOOR-2472-RT	24 x 72	1,006	2,218	812	1,107
	FLOOR-2484-RT	24 x 84	1,405	2,776	-	1,546
	FLOOR-2496-RT	24 x 96	1,520	3,103	-	1,671
	FLOOR-3036-RT	30 x 36	630	-	-	693
	FLOOR-3042-RT	30 x 42	673	1,621	-	741
	FLOOR-3048-RT	30 x 48	766	1,872	-	842
	FLOOR-3054-RT	30 x 54	961	2,152	-	1,056
	FLOOR-3060-RT	30 x 60	1,009	2,358	817	1,110
	FLOOR-3066-RT	30 x 66	1,060	2,493	-	1,166
	FLOOR-3072-RT	30 x 72	1,121	2,711	928	1,232
	FLOOR-3084-RT	30 x 84	1,624	3,467	-	1,786
	FLOOR-3096-RT	30 x 96	1,719	3,851	-	1,890
	FLOOR-3642-RT	36 x 42	773	1,773	-	850
	FLOOR-3648-RT	36 x 48	1,006	2,172	-	1,107
	FLOOR-3654-RT	36 x 54	1,053	2,310	-	1,158
	FLOOR-3660-RT	36 x 60	1,136	2,561	-	1,249
	FLOOR-3666-RT	36 x 66	1,236	2,750	-	1,360
FLOOR-3672-RT	36 x 72	1,267	2,946	-	1,393	
FLOOR-3684-RT	36 x 84	1,726	3,623	-	1,900	
FLOOR-3696-RT	36 x 96	1,820	4,013	-	2,002	

BREAKROOM & CAFÉ TABLES

**Floor Mounted**

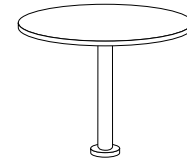

MODEL NUMBER	DESCRIPTION	ADD-ON PER COLUMN
-CH	Counter Height 36"	63
-BH	Bar Height 42"	63
-CUSTHT1	Custom Height between 5" - 28.99"	68
-CUSTHT2	Custom Height between 29" - 42"	131

**Accessories for Breakroom & Café Tables**

OPTION	DESCRIPTION	PRICE
Power & Data Management	Burele, EZ Power, Interact G2, Cove, Oasis, Stafford, Villa, Qi Wireless Charger	Visit SpecialT.net
Wire Management	Loop Clips, Velcro Loop, Cable Grip, J-shape Wire Channel, Snap Wire Channel, 1" Wire Channel, Metal Snap-On, Leg Clip	
Chairs	Task, Stacking, Flipper, Sled	

\*An Oversize Fee has been implemented by freight carriers for all LTL shipments for pallets 8' and over.  
96"-108" - additional 250.00 | 109"-168" - additional 350.00 | Per custom pallet

## BREAKROOM & CAFÉ TABLES

### Fusion

[CONFIGURE & PRICE](#)



	MODEL NUMBER	SIZE	HPL	WOOD VENEER	1-DAY	5-DAY
Round	FUSN-30	30"	937	1,504	-	1,031
	FUSN-36	36"	1,049	1,828	855	1,154
	FUSN-42	42"	1,207	2,169	1,014	1,328
Square	FUSN-3030	30 x 30	901	1,563	-	993
	FUSN-3636	36 x 36	1,000	1,911	805	1,102
	FUSN-4242	42 x 42	1,144	2,231	950	1,259

### Fusion Options

MODEL NUMBER	DESCRIPTION	ADD-ON
- BH	Bar Height 42"	97
- SC	Skate Casters	128
- SLG	Self Leveling Glides	84
- CUSTHT1	Custom Height between 5" - 28.99"	68
- CUSTHT2	Custom Height between 29" - 42"	165

### Accessories for Breakroom & Café Tables

OPTION	DESCRIPTION	PRICE
Power & Data Management	Burele, EZ Power, Interact G2, Cove, Oasis, Stafford, Villa, Qi Wireless Charger	Visit SpecialT.net
Wire Management	Loop Clips, Velcro Loop, Cable Grip, J-shape Wire Channel, Snap Wire Channel, 1" Wire Channel, Metal Snap-On, Leg Clip	
Chairs	Task, Stacking, Flipper, Sled	



BREAKROOM & CAFÉ TABLES

**Maxim**

CONFIGURE & PRICE

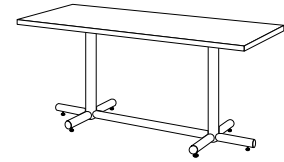

	MODEL NUMBER	SIZE	HPL	WOOD VENEER	1-DAY	5-DAY
	<b>Rectangle</b>	MAX-2460	24 x 60	999	2,024	803
MAX-2466		24 x 66	1,374	2,467	-	1,510
MAX-2472		24 x 72	1,430	2,642	1,236	1,571
MAX-2484		24 x 84	1,691	3,062	-	1,859
MAX-2496		24 x 96	1,847	3,430	-	2,033
MAX-3060		30 x 60	1,459	2,808	1,267	1,605
MAX-3066		30 x 66	1,505	2,938	-	1,655
MAX-3072		30 x 72	1,591	3,181	1,399	1,752
MAX-3084		30 x 84	1,951	3,794	-	2,145
MAX-3096		30 x 96	2,122	4,254	-	2,336
MAX-3660		36 x 60	1,626	3,051	-	1,711
MAX-3666		36 x 66	1,701	3,215	-	1,789
MAX-3672		36 x 72	1,753	3,432	-	1,844
MAX-3678		36 x 78	1,922	3,692	-	2,023
MAX-3684		36 x 84	2,039	3,936	-	2,194
MAX-3696		36 x 96	2,500	4,693	-	2,629
MAX-36108		36 x 108	2,732	5,915	-	-
MAX-36120		36 x 120	3,044	6,568	-	-
MAX-36144	36 x 144	3,645	7,697	-	-	

**Maxim Options**

MODEL NUMBER	DESCRIPTION	ADD-ON FOR TABLES UP TO 84" LONG	ADD-ON FOR TABLES 96-120" LONG	ADD-ON FOR TABLES 144" LONG
-BH	Bar Height 42"	126	189	252
-CA	Skate Casters	114	152	190
-SLG	Self Leveling Glides	126	168	210
-CUSTHT1	Custom Height: 5" - 28.99"	136	204	272
-CUSTHT2	Custom Height: 29" - 42"	262	393	524

**Accessories for Breakroom & Café Tables**

OPTION	DESCRIPTION	PRICE
Power & Data Management	Burele, EZ Power, Interact G2, Cove, Oasis, Stafford, Villa, Qi Wireless Charger	Visit SpecialT.net
Wire Management	Loop Clips, Velcro Loop, Cable Grip, J-shape Wire Channel, Snap Wire Channel, 1" Wire Channel, Metal Snap-On, Leg Clip	
Chairs	Task, Stacking, Flipper, Sled	

\*An Oversize Fee has been implemented by freight carriers for all LTL shipments for pallets 8' and over.  
96"-108" - additional 250.00 | 109"-168" - additional 350.00 | Per custom pallet

## BREAKROOM & CAFÉ TABLES

### Mount

[CONFIGURE & PRICE](#)

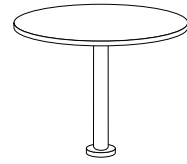

	MODEL NUMBER	SIZE	HPL	WOOD VENEER	1-DAY	5-DAY
Round	MONT-24	24"	647	1,016	-	711
	MONT-30	30"	726	1,293	-	800
	MONT-36	36"	821	1,600	626	902
Square	MONT-2424	24 x 24	622	1,090	-	685
	MONT-3030	30 x 30	696	1,358	-	765
	MONT-3636	36 x 36	780	1,691	588	857

### Mount Options

MODEL NUMBER	DESCRIPTION	ADD-ON
- BH	Bar Height 42"	85

### Accessories for Breakroom & Café Tables

OPTION	DESCRIPTION	PRICE
Power & Data Management	Burele, EZ Power	Visit SpecialT.net
Wire Management	Loop Clips, Velcro Loop, Cable Grip, J-shape Wire Channel, Snap Wire Channel, 1" Wire Channel	
Chairs	Task, Stacking, Flipper, Sled	

## BREAKROOM & CAFÉ TABLES

### Quatro

CONFIGURE & PRICE

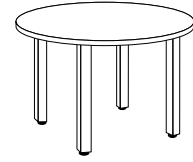

	MODEL NUMBER	SIZE	HPL	WOOD VENEER	1-DAY	5-DAY
Round	QUAT-24	24"	857	1,226	-	-
	QUAT-30	30"	953	1,520	-	-
	QUAT-36	36"	1,066	1,845	924	-
	QUAT-42	42"	1,220	2,182	1,087	-
	QUAT-48	48"	1,366	2,697	-	-
Square	QUAT-2424	24 x 24	829	1,297	-	-
	QUAT-3030	30 x 30	911	1,573	-	-
	QUAT-3636	36 x 36	1,015	1,926	869	-
	QUAT-4242	42 x 42	1,155	2,242	1,020	-
	QUAT-4848	48 x 48	1,291	2,786	-	-

### Quatro Options

MODEL NUMBER	DESCRIPTION	ADD-ON
-CA	Castors	76
-BH	Bar Height 42"	252
-CUSTHT1	Custom Height between 5" - 28.99"	272
-CUSTHT2	Custom Height between 29" - 42"	524

### Accessories for Breakroom & Café Tables

OPTION	DESCRIPTION	PRICE
Power & Data Management	Burele, EZ Power, Interact G2, Cove, Oasis, Stafford, Villa, Qi Wireless Charger	Visit SpecialT.net
Wire Management	Loop Clips, Velcro Loop, Cable Grip, J-shape Wire Channel, Snap Wire Channel, 1" Wire Channel, Metal Snap-On, Leg Clip	
Chairs	Task, Stacking, Flipper, Sled	

BREAKROOM & CAFÉ TABLES

**Reveal**

CONFIGURE & PRICE



	MODEL NUMBER	SIZE	HPL	WOOD VENEER	1-DAY	5-DAY
Round	REVL-24	24"	951	1,320	-	1,047
	REVL-30	30"	1,045	1,612	-	1,150
	REVL-36	36"	1,151	1,930	959	1,268
	REVL-42	42"	1,296	2,258	1,103	1,425
	REVL-48	48"	1,455	2,786	-	1,600
Square	REVL-2424	24 x 24	911	1,379	-	1,001
	REVL-3030	30 x 30	1,008	1,670	-	1,109
	REVL-3636	36 x 36	1,103	2,014	910	1,215
	REVL-4242	42 x 42	1,248	2,335	1,053	1,371
	REVL-4848	48 x 48	1,393	2,888	-	1,532
Rectangle	REVL-1824	18 x 24	778	1,146	-	855
	REVL-1830	18 x 30	802	1,235	-	884
	REVL-1836	18 x 36	832	1,344	-	915
	REVL-1842	18 x 42	867	1,432	-	954
	REVL-1848	18 x 48	913	1,571	-	1,003
	REVL-1854	18 x 54	935	1,645	-	1,030
	REVL-1860	18 x 60	959	1,764	765	1,054
	REVL-1866	18 x 66	1,047	1,903	-	1,153
	REVL-1872	18 x 72	1,096	2,046	902	1,206
	REVL-1878	18 x 78	1,227	2,228	-	1,349
	REVL-1884	18 x 84	1,361	2,436	-	1,498
	REVL-1896	18 x 96	1,452	2,694	-	1,598
	REVL-2430	24 x 30	847	1,400	-	933
	REVL-2436	24 x 36	878	1,558	-	965
	REVL-2442	24 x 42	921	1,643	-	1,014
	REVL-2448	24 x 48	959	1,800	765	1,054
	REVL-2454	24 x 54	994	1,902	-	1,093
	REVL-2460	24 x 60	1,031	2,056	836	1,133
	REVL-2466	24 x 66	1,151	2,244	-	1,268
	REVL-2472	24 x 72	1,207	2,419	1,015	1,331
REVL-2478	24 x 78	1,313	2,592	-	1,446	
REVL-2484	24 x 84	1,418	2,789	-	1,561	
REVL-2496	24 x 96	1,545	3,128	-	1,699	

BREAKROOM & CAFÉ TABLES

**Reveal**

CONFIGURE & PRICE

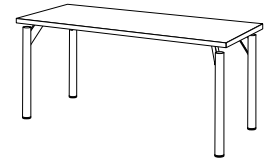

	MODEL NUMBER	SIZE	HPL	WOOD VENEER	1-DAY	5-DAY
	Rectangle	REVL-3042	30 x 42	978	1,926	-
REVL-3048		30 x 48	1,031	2,137	-	1,133
REVL-3054		30 x 54	1,092	2,283	-	1,201
REVL-3060		30 x 60	1,150	2,499	956	1,264
REVL-3066		30 x 66	1,256	2,689	-	1,384
REVL-3072		30 x 72	1,338	2,928	1,146	1,473
REVL-3078		30 x 78	1,501	3,179	-	1,652
REVL-3084		30 x 84	1,660	3,503	-	1,828
REVL-3096		30 x 96	1,763	3,895	-	1,939
REVL-3642		36 x 42	1,094	2,094	-	1,203
REVL-3648		36 x 48	1,150	2,316	-	1,264
REVL-3654		36 x 54	1,215	2,472	-	1,337
REVL-3660		36 x 60	1,287	2,712	-	1,417
REVL-3666		36 x 66	1,452	2,966	-	1,598
REVL-3672		36 x 72	1,499	3,178	-	1,650
REVL-3678		36 x 78	1,635	3,405	-	1,799
REVL-3684		36 x 84	1,776	3,673	-	1,953
REVL-3696		36 x 96	1,880	4,073	-	2,067

**Reveal Options**

MODEL NUMBER	DESCRIPTION	ADD-ON
-SLG	Self Leveling Glides	84
-CUSTHT1	Custom Height between 5" - 28.99"	272

**Accessories for Breakroom & Café Tables**

OPTION	DESCRIPTION	PRICE
Power & Data Management	Burele, EZ Power, Interact G2, Cove, Oasis, Stafford, Villa, Qi Wireless Charger	Visit SpecialT.net
Wire Management	Loop Clips, Velcro Loop, Cable Grip, J-shape Wire Channel, Snap Wire Channel, 1" Wire Channel, Metal Snap-On, Leg Clip	
Chairs	Task, Stacking, Flipper, Sled	

\*An Oversize Fee has been implemented by freight carriers for all LTL shipments for pallets 8' and over.  
96"-108" - additional 250.00 | 109"-168" - additional 350.00 | Per custom pallet

## BREAKROOM & CAFÉ TABLES

### Sienna Round

CONFIGURE & PRICE



	MODEL NUMBER	SIZE	HPL	WOOD VENEER	1-DAY	5-DAY
Round	SIEN-24	24"	816	1,185	-	897
	SIEN-30	30"	856	1,423	-	941
	SIEN-36	36"	935	1,714	742	1,030
	SIEN-42	42"	1,261	2,223	1,066	1,386
	SIEN-48	48"	1,320	2,651	-	1,454
Square	SIEN-2424	24 x 24	898	1,366	-	987
	SIEN-3030	30 x 30	964	1,626	-	1,061
	SIEN-3636	36 x 36	1,148	2,059	954	1,262
	SIEN-4242	42 x 42	1,240	2,327	1,045	1,363
	SIEN-4848	48 x 48	1,298	2,793	-	1,429

### Sienna Round Options

MODEL NUMBER	DESCRIPTION	ADD-ON
-BH	Bar Height 42"	63
-CUSTHT1	Custom Height between 5" - 28.99"	68
-CUSTHT2	Custom Height between 29" - 42"	131
-FR	Foot Ring*	104

\* Available only with Bar Height option

### Accessories for Breakroom & Cafe Tables

OPTION	DESCRIPTION	PRICE
Power & Data Management	Burele, EZ Power, Interact G2, Cove, Oasis, Stafford, Villa, Qi Wireless Charger	Visit SpecialT.net
Wire Management	Loop Clips, Velcro Loop, Cable Grip, J-shape Wire Channel, Snap Wire Channel, Wire Trough, 1" Wire Channel, Metal Snap-On, Leg Clip	
Chairs	Task, Stacking, Flipper, Sled	

BREAKROOM & CAFÉ TABLES

**Sienna Square**

CONFIGURE & PRICE

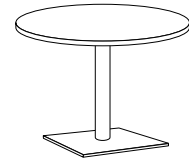

	MODEL NUMBER	SIZE	HPL	WOOD VENEER	1-DAY	5-DAY
<b>Round</b>	SIENS-24	24"	816	1,185	-	897
	SIENS-30	30"	856	1,423	-	941
	SIENS-36	36"	935	1,714	-	1,030
	SIENS-42	42"	1,261	2,223	-	1,386
	SIENS-48	48"	1,320	1,788	-	1,454
<b>Square</b>	SIENS-2424	24 x 24	898	1,366	-	987
	SIENS-3030	30 x 30	964	1,626	-	1,061
	SIENS-3636	36 x 36	1,148	2,059	-	1,262
	SIENS-4242	42 x 42	1,240	2,327	-	1,363
	SIENS-4848	48 x 48	1,298	2,793	-	1,429

**Sienna Square Options**

MODEL NUMBER	DESCRIPTION	ADD-ON
-BH	Bar Height 42"	63
-CUSTHT1	Custom Height between 5" - 28.99"	68
-CUSTHT2	Custom Height between 29" - 42"	131
-FR	Foot Ring*	104

\* Available only with Bar Height option

**Accessories for Breakroom & Cafe Tables**

OPTION	DESCRIPTION	PRICE
Power & Data Management	Burele, EZ Power, Interact G2, Cove, Oasis, Stafford, Villa, Qi Wireless Charger	Visit SpecialT.net
Wire Management	Loop Clips, Velcro Loop, Cable Grip, J-shape Wire Channel, Snap Wire Channel, 1" Wire Channel, Metal Snap-On, Leg Clip	
Chairs	Task, Stacking, Flipper, Sled	

BREAKROOM & CAFÉ TABLES

**Sienna Café Power**

**CONFIGURE & PRICE**

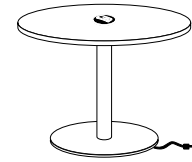

	MODEL NUMBER	SIZE	HPL	WOOD VENEER	1-DAY	5-DAY
Round	SIEN-CP-30	30"	1,823	2,390	-	2,005
	SIEN-CP-36	36"	1,946	2,725	-	2,143
	SIEN-CP-42	42"	2,320	3,282	-	2,551
	SIEN-CP-48	48"	2,372	3,703	-	2,610
Square	SIEN-CP-3030	30 x 30	1,611	2,273	-	1,771
	SIEN-CP-3636	36 x 36	1,707	2,618	-	1,877
	SIEN-CP-4242	42 x 42	2,094	3,181	-	2,304
	SIEN-CP-4848	48 x 48	2,116	3,611	-	2,327

**Sienna Café Power Options**

MODEL NUMBER	DESCRIPTION	ADD-ON
-BH	Bar Height 42"	63
-CUSTHT1	Custom Height between 5" - 28.99"	68
-CUSTHT2	Custom Height between 29" - 42"	131
-FR	Foot Ring*	104

\* Available only with Bar Height option

**Accessories for Breakroom & Cafe Tables**

OPTION	DESCRIPTION	PRICE
Power & Data Management	Node	Visit SpecialT.net
Chairs	Task, Stacking, Flipper, Sled	



BREAKROOM & CAFÉ TABLES

**SiennaX**

**CONFIGURE & PRICE**

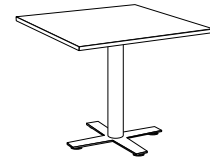

	MODEL NUMBER	SIZE	HPL	WOOD VENEER	1-DAY	5-DAY
Round	SIENX-30	30"	926	1,493	-	1,018
	SIENX-36	36"	1,105	1,884	910	1,215
	SIENX-42	42"	1,340	2,302	1,147	1,474
Square	SIENX-3030	30 x 30	896	1,558	-	985
	SIENX-3636	36 x 36	1,061	1,972	868	1,168
	SIENX-4242	42 x 42	1,286	2,373	1,093	1,416

**SiennaX Options**

MODEL NUMBER	DESCRIPTION	ADD-ON
-BH	Bar Height 42"	63
-SC	Skate Casters	128
-CUSTHT1	Custom Height between 5" - 28.99"	68
-CUSTHT2	Custom Height between 29" - 42"	131
-FR	Foot Ring*	104

\* Available only with Bar Height option

**Accessories for Breakroom & Cafe Tables**

OPTION	DESCRIPTION	PRICE
Power & Data Management	Burele, EZ Power	Visit SpecialT.net
Wire Management	Loop Clips, Velcro Loop, Cable Grip, J-shape Wire Channel, Snap Wire Channel, 1" Wire Channel	
Chairs	Task, Stacking, Flipper, Sled	

BREAKROOM & CAFÉ TABLES

**Sienna X Café Power**

**CONFIGURE & PRICE**

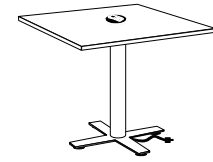

	MODEL NUMBER	SIZE	HPL	WOOD VENEER	1-DAY	5-DAY
Round	SIENX-CP-30	30"	1,823	2,390	-	2,005
	SIENX-CP-36	36"	2,019	2,798	-	2,222
	SIENX-CP-42	42"	2,379	3,341	-	2,617
Square	SIENX-CP-3030	30 x 30	1,611	2,273	-	1,771
	SIENX-CP-3636	36 x 36	1,779	2,690	-	1,957
	SIENX-CP-4242	42 x 42	2,151	3,238	-	2,367

**SiennaX Café Power Options**

MODEL NUMBER	DESCRIPTION	ADD-ON
-BH	Bar Height 42"	\$63
-SC	Skate Casters	\$128
-CUSTHT1	Custom Height between 5" - 28.99"	\$68
-CUSTHT2	Custom Height between 29" - 42"	\$131
-FR	Foot Ring*	\$104

\* Available only with Bar Height option

**Accessories for Breakroom & Cafe Tables**

OPTION	DESCRIPTION	PRICE
Power & Data Management	Node	Visit SpecialT.net
Chairs	Task, Stacking, Flipper, Sled	

BREAKROOM & CAFÉ TABLES

**StarX-2**

CONFIGURE & PRICE



	MODEL NUMBER	SIZE	HPL	WOOD VENEER	1-DAY	5-DAY
Round	STRX2-24	24"	525	894	-	578
	STRX2-30	30"	620	1,187	-	684
	STRX2-36	36"	768	1,547	575	845
	STRX2-42	42"	928	1,890	735	1,022
Square	STRX2-2424	24 x 24	494	962	-	547
	STRX2-3030	30 x 30	582	1,244	-	643
	STRX2-3636	36 x 36	721	1,632	525	792
	STRX2-4242	42 x 42	867	1,954	673	954
Rectangle	STRX2-2436	24 x 36	593	1,273	-	655
	STRX2-2442	24 x 42	652	1,374	-	717
	STRX2-2448	24 x 48	686	1,527	492	-
	STRX2-3048	30 x 48	721	1,827	-	792

**StarX-2 Options**

MODEL NUMBER	DESCRIPTION	ADD-ON
-BH	Bar Height 42"	98
-FR	Foot Ring*	104
-SLG	Self Leveling Glides	84

\* Available only with Bar Height option

**Accessories for Breakroom & Cafe Tables**

OPTION	DESCRIPTION	PRICE
Power & Data Management	Burele, EZ Power	Visit SpecialT.net
Wire Management	Loop Clips, Velcro Loop, Cable Grip, J-shape Wire Channel, Snap Wire Channel, 1" Wire Channel	
Chairs	Task, Stacking, Flipper, Sled	

BREAKROOM & CAFÉ TABLES

**Structure 4X**

**CONFIGURE & PRICE**



MODEL NUMBER	SIZE	HPL	WOOD VENEER	1-DAY	5-DAY
--------------	------	-----	-------------	-------	-------

**29" Height Tables**

	MODEL NUMBER	SIZE	HPL	WOOD VENEER	1-DAY	5-DAY
<b>Round</b>	STRU-4X-24	24"	799	1,168	-	878
	STRU-4X-30	30"	911	1,478	-	1,001
	STRU-4X-36	36"	1,065	1,844	872	1,171
	STRU-4X-42	42"	1,256	2,218	1,061	1,382
<b>Square</b>	STRU-4X-2424	24 x 24	924	1,392	-	1,017
	STRU-4X-3030	30 x 30	1,111	1,773	-	1,225
	STRU-4X-3636	36 x 36	1,236	2,147	1,042	1,360
	STRU-4X-4242	42 x 42	1,471	2,558	1,279	1,619

**Structure 4X Options**

MODEL NUMBER	DESCRIPTION	ADD-ON
-BH	Bar Height 42"	64
-OH	Occasional height 16"	-51

**Accessories for Breakroom & Cafe Tables**

OPTION	DESCRIPTION	PRICE
Power & Data Management	Burele, EZ Power	Visit SpecialT.net
Wire Management	Loop Clips, Velcro Loop, Cable Grip, J-Shape Wire Channel, Wire Trough, Wire Tray, 1" Wire Channel, Magnetic Channel, Adjustable Spine	
Chairs	Task, Stacking, Flipper, Sled	

## BREAKROOM & CAFÉ TABLES

### Success

[CONFIGURE & PRICE](#)

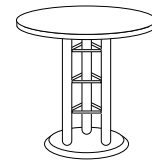

	MODEL NUMBER	SIZE	HPL	WOOD VENEER	1-DAY	5-DAY
Round	SCSS-24	24"	1,056	1,425	-	1,163
	SCSS-30	30"	1,150	1,717	-	1,264
	SCSS-36	36"	1,352	2,131	1,159	1,485
	SCSS-42	42"	1,620	2,582	1,426	1,784
Square	SCSS-2424	24 x 24	1,027	1,495	-	1,129
	SCSS-3030	30 x 30	1,111	1,773	-	1,225
	SCSS-3636	36 x 36	1,301	2,212	1,107	1,430
	SCSS-4242	42 x 42	1,558	2,645	1,364	1,713

### Success Options

MODEL NUMBER	DESCRIPTION	ADD-ON
-BH	Bar Height 42"	91
-CUSTHT1	Custom Height between 5" - 28.99"	204
-CUSTHT2	Custom Height between 29" - 42"	295

### Accessories for Breakroom & Cafe Tables

OPTION	DESCRIPTION	PRICE
Power & Data Management	Burele, EZ Power	Visit SpecialT.net
Wire Management	Loop Clips, Velcro Loop, Cable Grip, J-shape Wire Channel, Snap Wire Channel, 1" Wire Channel, Metal Sap-On, Leg Clip	
Chairs	Task, Stacking, Flipper, Sled	

## BREAKROOM & CAFÉ TABLES

### Tempo

[CONFIGURE & PRICE](#)



	MODEL NUMBER	SIZE	HPL	WOOD VENEER	1-DAY	5-DAY
Round	TMPO-24	24"	856	1,225	-	1,163
	TMPO-30	30"	935	1,502	-	1,264
	TMPO-36	36"	1,205	1,984	-	1,485
Square	TMPO-2424	24 x 24	832	1,300	-	915
	TMPO-3030	30 x 30	905	1,567	1,012	995
	TMPO-3636	36 x 36	1,164	2,075	972	1,280

### Tempo Options

MODEL NUMBER	DESCRIPTION	ADD-ON
-BH	Bar Height 42"	85

### Accessories for Breakroom & Cafe Tables

OPTION	DESCRIPTION	PRICE
Power & Data Management	Burele, EZ Power	Visit SpecialT.net
Wire Management	Loop Clips, Velcro Loop, Cable Grip, J-shape Wire Channel, Snap Wire Channel, 1" Wire Channel	
Chairs	Task, Stacking, Flipper, Sled	

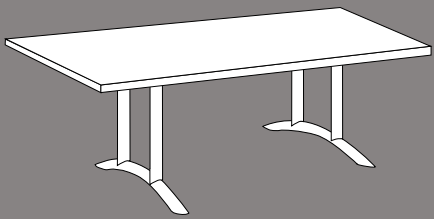

## CONFERENCE TABLES

CONFERENCE TABLES

**AIM XL**

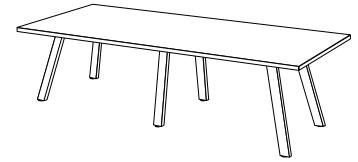

CONFIGURE & PRICE

	MODEL NUMBER	SIZE	CONFIGURE & PRICE		1-DAY	5-DAY
			HPL	WOOD VENEER		
Rectangle	AIM-XL-3672	36 x 72	2,082	3,761	-	-
	AIM-XL-3678	36 x 78	2,138	3,908	-	-
	AIM-XL-3684	36 x 84	2,213	4,110	-	-
	AIM-XL-3696	36 x 96	2,539	4,732	-	-
	AIM-XL-36108	36 x 108	2,887	6,070	-	-
	AIM-XL-36120	36 x 120	2,908	6,432	-	-
	AIM-XL-36144	36 x 144	3,152	7,204	-	-
	AIM-XL-36168	36 x 168	3,817	9,631	-	-
	AIM-XL-36192	36 x 192	3,995	10,638	-	-
	AIM-XL-36216	36 x 216	4,492	12,762	-	-
	AIM-XL-4278	42 x 78	2,417	4,342	-	-
	AIM-XL-4284	42 x 84	2,571	4,635	-	-
	AIM-XL-4296	42 x 96	2,755	5,151	-	-
	AIM-XL-42108	42 x 108	3,214	6,595	-	-
	AIM-XL-42120	42 x 120	3,368	7,139	-	-
	AIM-XL-42144	42 x 144	3,673	8,018	-	-
	AIM-XL-42168	42 x 168	4,364	10,579	-	-
	AIM-XL-42192	42 x 192	4,570	11,712	-	-
	AIM-XL-42216	42 x 216	5,208	13,974	-	-
	AIM-XL-4884	48 x 84	2,632	5,057	-	-
	AIM-XL-4896	48 x 96	2,786	5,589	-	-
	AIM-XL-48108	48 x 108	3,321	7,159	-	-
	AIM-XL-48120	48 x 120	3,519	7,796	-	-
	AIM-XL-48144	48 x 144	3,979	8,925	-	-
	AIM-XL-48168	48 x 168	4,374	11,493	-	-
	AIM-XL-48192	48 x 192	4,581	12,746	-	-
	AIM-XL-48216	48 x 216	5,218	15,135	-	-
	AIM-XL-6096	60 x 96	2,908	6,324	-	-
	AIM-XL-60108	60 x 108	3,627	8,121	-	-
	AIM-XL-60120	60 x 120	3,749	8,778	-	-
AIM-XL-60144	60 x 144	4,286	10,126	-	-	
AIM-XL-60168	60 x 168	4,932	13,355	-	-	
AIM-XL-60192	60 x 192	5,158	14,865	-	-	
AIM-XL-60216	60 x 216	5,934	17,506	-	-	



CONFERENCE TABLES

**AIM XL**

CONFIGURE & PRICE

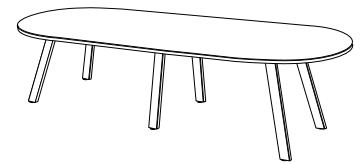

	MODEL NUMBER	SIZE	CONFIGURE & PRICE		1-DAY	5-DAY
			HPL	WOOD VENEER		
Racetrack	AIM-XL-3672-RC	36 x 72	2,233	3,707	-	-
	AIM-XL-3678-RC	36 x 78	2,292	3,790	-	-
	AIM-XL-3684-RC	36 x 84	2,367	3,997	-	-
	AIM-XL-3696-RC	36 x 96	2,693	4,629	-	-
	AIM-XL-36108-RC	36 x 108	3,040	5,903	-	-
	AIM-XL-36120-RC	36 x 120	3,062	6,729	-	-
	AIM-XL-36144-RC	36 x 144	3,306	7,083	-	-
	AIM-XL-36168-RC	36 x 168	4,354	9,656	-	-
	AIM-XL-36192-RC	36 x 192	4,502	10,659	-	-
	AIM-XL-36216-RC	36 x 216	4,930	12,783	-	-
	AIM-XL-4278-RC	42 x 78	2,571	4,186	-	-
	AIM-XL-4284-RC	42 x 84	2,724	4,539	-	-
	AIM-XL-4296-RC	42 x 96	2,815	4,971	-	-
	AIM-XL-42108-RC	42 x 108	3,368	6,454	-	-
	AIM-XL-42120-RC	42 x 120	3,519	7,002	-	-
	AIM-XL-42144-RC	42 x 144	3,826	7,920	-	-
	AIM-XL-42168-RC	42 x 168	4,862	10,601	-	-
	AIM-XL-42192-RC	42 x 192	5,040	11,730	-	-
	AIM-XL-42216-RC	42 x 216	5,616	13,982	-	-
	AIM-XL-4884-RC	48 x 84	2,755	4,936	-	-
	AIM-XL-4896-RC	48 x 96	2,832	5,405	-	-
	AIM-XL-48108-RC	48 x 108	3,474	7,024	-	-
	AIM-XL-48120-RC	48 x 120	3,673	7,672	-	-
	AIM-XL-48144-RC	48 x 144	4,132	8,835	-	-
	AIM-XL-48168-RC	48 x 168	4,872	11,515	-	-
	AIM-XL-48192-RC	48 x 192	5,040	12,767	-	-
	AIM-XL-48216-RC	48 x 216	5,636	15,153	-	-
	AIM-XL-6096-RC	60 x 96	2,937	6,065	-	-
	AIM-XL-60108-RC	60 x 108	3,780	7,931	-	-
	AIM-XL-60120-RC	60 x 120	3,902	8,598	-	-
	AIM-XL-60144-RC	60 x 144	4,438	9,982	-	-
	AIM-XL-60168-RC	60 x 168	5,598	13,382	-	-
AIM-XL-60192-RC	60 x 192	5,794	14,891	-	-	
AIM-XL-60216-RC	60 x 216	6,501	17,531	-	-	

CONFERENCE TABLES

**AIM XL**

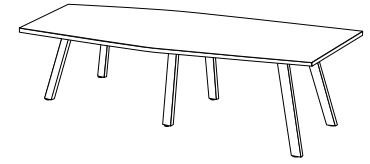

CONFIGURE & PRICE

	MODEL NUMBER	SIZE	HPL	WOOD VENEER	1-DAY	5-DAY
Boat Shape	AIM-XL-3672-BT	36 x 72	2,233	3,858	-	-
	AIM-XL-3678-BT	37 x 78	2,292	3,936	-	-
	AIM-XL-3684-BT	36 x 84	2,367	4,146	-	-
	AIM-XL-3696-BT	36 x 96	2,693	4,780	-	-
	AIM-XL-36108-BT	36 x 108	3,040	6,054	-	-
	AIM-XL-36120-BT	36 x 120	3,062	6,430	-	-
	AIM-XL-36144-BT	36 x 144	3,306	7,233	-	-
	AIM-XL-36168-BT	36 x 168	4,354	9,846	-	-
	AIM-XL-36192-BT	36 x 192	4,502	10,851	-	-
	AIM-XL-36216-BT	36 x 216	4,930	12,973	-	-
	AIM-XL-4278-BT	42 x 78	2,571	4,293	-	-
	AIM-XL-4284-BT	42 x 84	2,724	4,642	-	-
	AIM-XL-4296-BT	42 x 96	2,815	5,072	-	-
	AIM-XL-42108-BT	42 x 108	3,368	6,543	-	-
	AIM-XL-42120-BT	42 x 120	3,519	7,089	-	-
	AIM-XL-42144-BT	42 x 144	3,826	7,990	-	-
	AIM-XL-42168-BT	42 x 168	4,862	10,667	-	-
	AIM-XL-42192-BT	42 x 192	5,040	11,788	-	-
	AIM-XL-42216-BT	42 x 216	5,616	14,019	-	-
	AIM-XL-4884-BT	48 x 84	2,755	5,082	-	-
	AIM-XL-4896-BT	48 x 96	2,832	5,552	-	-
	AIM-XL-48108-BT	48 x 108	3,474	7,170	-	-
	AIM-XL-48120-BT	48 x 120	3,673	7,818	-	-
	AIM-XL-48144-BT	48 x 144	4,132	8,981	-	-
	AIM-XL-48168-BT	48 x 168	4,872	11,705	-	-
	AIM-XL-48192-BT	48 x 192	5,040	12,957	-	-
	AIM-XL-48216-BT	48 x 216	5,636	15,343	-	-
	AIM-XL-6096-BT	60 x 96	2,937	6,211	-	-
	AIM-XL-60108-BT	60 x 108	3,780	8,077	-	-
	AIM-XL-60120-BT	60 x 120	3,902	8,745	-	-
	AIM-XL-60144-BT	60 x 144	4,438	10,129	-	-
	AIM-XL-60168-BT	60 x 168	5,598	13,573	-	-
AIM-XL-60192-BT	60 x 192	5,794	15,082	-	-	
AIM-XL-60216-BT	60 x 216	6,501	17,723	-	-	

CONFERENCE TABLES

**AIM XL**

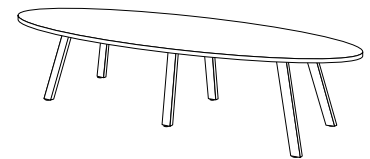

CONFIGURE & PRICE

	MODEL NUMBER	SIZE	HPL	WOOD VENEER	1-DAY	5-DAY
Oval	AIM-XL-3672-OV	36 x 72	2,233	3,767	-	-
	AIM-XL-3678-OV	37 x 78	2,292	3,846	-	-
	AIM-XL-3684-OV	36 x 84	2,367	4,058	-	-
	AIM-XL-3696-OV	36 x 96	2,693	4,693	-	-
	AIM-XL-36108-OV	36 x 108	3,040	5,964	-	-
	AIM-XL-36120-OV	36 x 120	3,062	6,344	-	-
	AIM-XL-36144-OV	36 x 144	3,306	7,154	-	-
	AIM-XL-36168-OV	36 x 168	4,354	9,749	-	-
	AIM-XL-36192-OV	36 x 192	4,502	10,774	-	-
	AIM-XL-36216-OV	36 x 216	4,930	12,905	-	-
	AIM-XL-4278-OV	42 x 78	2,571	4,231	-	-
	AIM-XL-4284-OV	42 x 84	2,724	4,582	-	-
	AIM-XL-4296-OV	42 x 96	2,815	5,019	-	-
	AIM-XL-42108-OV	42 x 108	3,368	6,497	-	-
	AIM-XL-42120-OV	42 x 120	3,519	7,050	-	-
	AIM-XL-42144-OV	42 x 144	3,826	7,971	-	-
	AIM-XL-42168-OV	42 x 168	4,862	10,667	-	-
	AIM-XL-42192-OV	42 x 192	5,040	11,816	-	-
	AIM-XL-42216-OV	42 x 216	5,616	14,075	-	-
	AIM-XL-4884-OV	48 x 84	2,755	4,968	-	-
	AIM-XL-4896-OV	48 x 96	2,832	5,436	-	-
	AIM-XL-48108-OV	48 x 108	3,474	7,049	-	-
	AIM-XL-48120-OV	48 x 120	3,673	7,698	-	-
	AIM-XL-48144-OV	48 x 144	4,132	8,867	-	-
	AIM-XL-48168-OV	48 x 168	4,872	11,560	-	-
	AIM-XL-48192-OV	48 x 192	5,040	12,834	-	-
	AIM-XL-48216-OV	48 x 216	5,636	15,220	-	-
	AIM-XL-6096-OV	60 x 96	2,937	6,069	-	-
	AIM-XL-60108-OV	60 x 108	3,780	7,931	-	-
	AIM-XL-60120-OV	60 x 120	3,902	8,597	-	-
	AIM-XL-60144-OV	60 x 144	4,438	9,324	-	-
	AIM-XL-60168-OV	60 x 168	5,598	13,393	-	-
AIM-XL-60192-OV	60 x 192	5,794	14,900	-	-	
AIM-XL-60216-OV	60 x 216	6,501	17,551	-	-	

CONFERENCE TABLES

**AIM XL**

CONFIGURE & PRICE

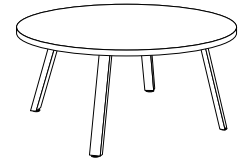

	MODEL NUMBER	SIZE	HPL	WOOD VENEER	1-DAY	5-DAY
<b>Round</b>	AIM-XL-42R	42"	1,928	2,890	-	-
	AIM-XL-48R	48"	1,989	3,320	-	-
	AIM-XL-54R	54"	2,265	3,779	-	-
	AIM-XL-60R	60"	2,295	4,274	-	-
	AIM-XL-66R	66"	3,275	5,983	-	-
	AIM-XL-72R	72"	3,336	6,559	-	-
<b>Square</b>	AIM-XL-4242	42" x 42"	1,836	2,923	-	-
	AIM-XL-4848	48" x 48"	1,913	3,408	-	-
	AIM-XL-5454	54" x 54"	2,265	3,984	-	-
	AIM-XL-6060	60" x 60"	2,417	4,636	-	-
	AIM-XL-6666	66" x 66"	2,755	5,923	-	-
	AIM-XL-7272	72" x 72"	2,908	6,666	-	-

**AIMXL Options**

MODEL NUMBER	DESCRIPTION	ADD-ON		
		UP TO 84" LONG	96" - 144" LONG	168" - 216" LONG
-BH	Bar Height 42"	60	90	120
-CC	Cloud Caster	60	90	120
-WM-INT	Integrated Wire Management	73 per Leg		
	2 Piece Tabletop Standard for sizes over 108"	-	-	-
	1 Piece Tabletop for sizes up to 168"	586	586	586

**Accessories for Conference Tables**

OPTION	DESCRIPTION	PRICE
Grommet	Round or Rectangle	Visit SpecialT.net
Power & Data Management	Burele, EZ Power, Interact G2, Cove, Oasis, Stafford, Villa, Qi Wireless Charger	
Wire Management	Loop Clips, Velcro Loop, Cable Grip, J-shape Wire Channel, Snap Wire Channel, Wire Trough, Wire Tray, 1" Wire Channel, Magnetic Channel, Adjustable Spine, Integrated	
Chairs	Task, Stacking, Flipper, Sled	

\*An Oversize Fee has been implemented by freight carriers for all LTL shipments for pallets 8' and over.  
96"-108" - additional 250.00 | 109"-168" - additional 350.00 | Per custom pallet

CONFERENCE TABLES

**Astra**

CONFIGURE & PRICE

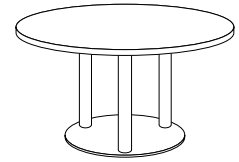

	MODEL NUMBER	SIZE	HPL	WOOD VENEER	1-DAY	5-DAY
Round	ASTR-48	48"	2,316	3,647	-	-
	ASTR-54	54"	2,470	3,984	-	-
	ASTR-60	60"	2,911	4,890	-	-
Rectangle	ASTR-4884-RT	48 x 84	3,342	5,767	-	-
	ASTR-4896-RT	48 x 96	3,430	6,233	-	-
	ASTR-48108-RT	48 x 108	4,010	7,848	-	-
	ASTR-48120-RT	48 x 120	4,051	8,328	-	-
	ASTR-48144-RT	48 x 144	4,365	9,311	-	-
	ASTR-6096-RT	60 x 96	3,761	7,177	-	-
	ASTR-60108-RT	60 x 108	4,407	8,901	-	-
	ASTR-60120-RT	60 x 120	4,430	9,459	-	-
Racetrack	ASTR-4884-RC	36 x 60	3,658	5,839	-	-
	ASTR-4896-RC	48 x 96	3,731	6,304	-	-
	ASTR-48108-RC	48 x 108	4,385	7,935	-	-
	ASTR-48120-RC	48 x 120	4,414	8,413	-	-
	ASTR-48144-RC	48 x 144	4,683	9,386	-	-
	ASTR-6096-RC	60 x 96	4,139	7,267	-	-
	ASTR-60108-RC	60 x 108	4,856	9,007	-	-
	ASTR-60120-RC	60 x 120	4,865	9,561	-	-
Boat Shape	ASTR-4884-BT	36 x 60	3,658	5,985	-	-
	ASTR-4896-BT	48 x 96	3,731	6,451	-	-
	ASTR-48108-BT	48 x 108	4,385	8,081	-	-
	ASTR-48120-BT	48 x 120	4,414	8,559	-	-
	ASTR-48144-BT	48 x 144	4,683	9,532	-	-
	ASTR-6096-BT	60 x 96	4,139	7,413	-	-
	ASTR-60108-BT	60 x 108	4,856	9,153	-	-
	ASTR-60120-BT	60 x 120	4,865	9,708	-	-
ASTR-60144-BT	60 x 144	5,198	10,889	-	-	

CONFERENCE TABLES

**Astra Options**

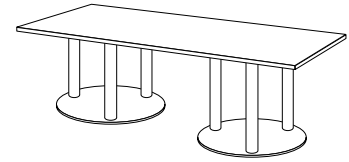

DESCRIPTION	ADD-ON
2 Piece Tabletop Standard for sizes over 108"	-
1 Piece Tabletop	586

**Accessories for Conference Tables**

OPTION	DESCRIPTION	PRICE
Grommet	Round or Rectangle	Visit SpecialT.net
Power & Data Management	Burele, EZ Power, Interact G2, Cove, Oasis, Stafford, Villa, Qi Wireless Charger	
Wire Management	Loop Clips, Velcro Loop, Cable Grip, J-shape Wire Channel, Snap Wire Channel, Wire Trough, Wire Tray, 1" Wire Channel, Adjustable Spine	
Chairs	Task, Stacking, Flipper, Sled	

\*An Oversize Fee has been implemented by freight carriers for all LTL shipments for pallets 8' and over.  
96"-108" - additional 250.00 | 109" -168" - additional 350.00 | Per custom pallet

CONFERENCE TABLES

**Atlantis**

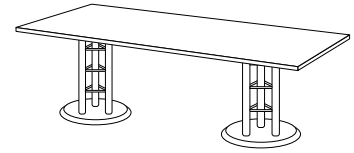

CONFIGURE & PRICE

	MODEL NUMBER	SIZE	HPL	WOOD VENEER	1-DAY	5-DAY
Rectangle	ATLS-3660-RT	36 x 60	2,472	3,897	-	-
	ATLS-3666-RT	36 x 66	2,537	4,051	-	-
	ATLS-3672-RT	36 x 72	2,583	4,262	-	-
	ATLS-3678-RT	36 x 78	2,755	4,525	-	-
	ATLS-3684-RT	36 x 84	2,871	4,768	-	-
	ATLS-3696-RT	36 x 96	2,980	5,173	-	-
	ATLS-36108-RT	36 x 108	3,622	6,805	-	-
	ATLS-36120-RT	36 x 120	4,922	8,446	-	-
	ATLS-36144-RT	36 x 144	5,199	9,251	-	-
	ATLS-4278-RT	42 x 78	2,877	4,802	-	-
	ATLS-4284-RT	42 x 84	3,165	5,229	-	-
	ATLS-4296-RT	42 x 96	3,359	5,755	-	-
	ATLS-42108-RT	42 x 108	3,880	7,261	-	-
	ATLS-42120-RT	42 x 120	5,078	8,849	-	-
	ATLS-42144-RT	42 x 144	5,475	9,820	-	-
	ATLS-4884-RT	48 x 84	3,643	6,068	-	-
	ATLS-4896-RT	48 x 96	3,806	6,609	-	-
	ATLS-48108-RT	48 x 108	4,518	8,356	-	-
	ATLS-48120-RT	48 x 120	5,744	10,021	-	-
	ATLS-48144-RT	48 x 144	6,079	11,025	-	-
Racetrack	ATLS-3660-RC	36 x 60	2,647	-	-	-
	ATLS-3666-RC	36 x 66	2,765	-	-	-
	ATLS-3672-RC	36 x 72	2,813	4,287	-	-
	ATLS-3678-RC	36 x 78	3,029	4,527	-	-
	ATLS-3684-RC	36 x 84	3,174	4,804	-	-
	ATLS-3696-RC	36 x 96	3,395	5,331	-	-
	ATLS-36108-RC	36 x 108	3,962	6,825	-	-
	ATLS-36120-RC	36 x 120	5,344	9,011	-	-
	ATLS-36144-RC	36 x 144	5,755	9,532	-	-
	ATLS-4278-RC	42 x 78	3,183	4,798	-	-
	ATLS-4284-RC	42 x 84	3,541	5,356	-	-
	ATLS-4296-RC	42 x 96	3,780	5,936	-	-
	ATLS-42108-RC	42 x 108	4,251	7,337	-	-
	ATLS-42120-RC	42 x 120	5,452	8,935	-	-
	ATLS-42144-RC	42 x 144	6,056	10,150	-	-
	ATLS-4884-RC	48 x 84	4,040	6,221	-	-
	ATLS-4896-RC	48 x 96	4,334	6,907	-	-
	ATLS-48108-RC	48 x 108	4,955	8,505	-	-
	ATLS-48120-RC	48 x 120	6,342	10,341	-	-
	ATLS-48144-RC	48 x 144	6,730	11,433	-	-

CONFERENCE TABLES

**Atlantis**

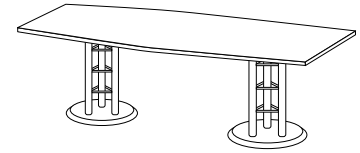

CONFIGURE & PRICE

	MODEL NUMBER	SIZE	HPL	WOOD VENEER	1-DAY	5-DAY
Boat Shape	ATLS-3660-BT	36 x 60	2,689	-	-	-
	ATLS-3666-BT	36 x 66	2,809	-	-	-
	ATLS-3672-BT	36 x 72	2,856	4,481	-	-
	ATLS-3684-BT	36 x 84	3,229	5,008	-	-
	ATLS-3696-BT	36 x 96	3,463	5,550	-	-
	ATLS-36108-BT	36 x 108	3,947	6,961	-	-
	ATLS-36120-BT	36 x 120	5,349	8,717	-	-
	ATLS-36144-BT	36 x 144	5,822	9,749	-	-
	ATLS-4278-BT	42 x 78	3,241	4,963	-	-
	ATLS-4284-BT	42 x 84	3,614	5,532	-	-
	ATLS-4296-BT	42 x 96	3,865	6,122	-	-
	ATLS-42108-BT	42 x 108	4,341	7,516	-	-
	ATLS-42120-BT	42 x 120	5,551	9,121	-	-
	ATLS-42144-BT	42 x 144	6,180	10,344	-	-
	ATLS-4884-BT	48 x 84	4,122	6,449	-	-
	ATLS-4896-BT	48 x 96	4,426	7,146	-	-
	ATLS-48108-BT	48 x 108	5,058	8,754	-	-
	ATLS-48120-BT	48 x 120	6,462	10,607	-	-
ATLS-48144-BT	48 x 144	6,868	11,717	-	-	
Oval	ATLS-3660-OV	36 x 60	2,805	-	-	-
	ATLS-3666-OV	36 x 66	2,943	-	-	-
	ATLS-3672-OV	36 x 72	3,083	4,617	-	-
	ATLS-3684-OV	36 x 84	3,410	5,101	-	-
	ATLS-3696-OV	36 x 96	3,657	5,657	-	-
	ATLS-36108-OV	36 x 108	4,178	7,102	-	-
	ATLS-36120-OV	36 x 120	5,627	8,909	-	-
	ATLS-36144-OV	36 x 144	6,155	10,003	-	-
	ATLS-4278-OV	42 x 78	3,419	5,079	-	-
	ATLS-4284-OV	42 x 84	3,838	5,696	-	-
	ATLS-4296-OV	42 x 96	4,121	6,325	-	-
	ATLS-42108-OV	42 x 108	4,617	7,746	-	-
	ATLS-42120-OV	42 x 120	5,854	9,385	-	-
	ATLS-42144-OV	42 x 144	6,555	10,700	-	-
	ATLS-4884-OV	48 x 84	4,362	6,575	-	-
	ATLS-4896-OV	48 x 96	4,688	7,292	-	-
	ATLS-48108-OV	48 x 108	5,373	8,948	-	-
	ATLS-48120-OV	48 x 120	6,823	10,848	-	-
ATLS-48144-OV	48 x 144	7,289	12,024	-	-	



CONFERENCE TABLES

**Atlantis Options**

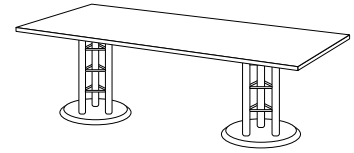

MODEL NUMBER	DESCRIPTION	ADD-ON	
		UP TO 96" LONG	108" -144" LONG
-BH	Bar Height 42"	182	273
	2 Piece Tabletop Standard for sizes over 108"	-	-
	1 Piece Tabletop for sizes up to 168"	-	586

**Other Options for Conference Tables**

OPTION	DESCRIPTION	PRICE
Grommet	Round or Rectangle	Visit SpecialT.net
Power & DataManagement	Burele, EZ Power, Interact G2, Cove, Oasis, Stafford, Villa, Qi Wireless Charger	
Wire Management	Loop Clips, Velcro Loop, Cable Grip, J-shape Wire Channel, Snap Wire Channel, Wire Trough, Wire Tray, 1" Wire Channel, Adjustable Spine	
Chairs	Task, Stacking, Flipper, Sled	

\*An Oversize Fee has been implemented by freight carriers for all LTL shipments for pallets 8' and over.  
96"-108" - additional 250.00 | 109" -168" - additional 350.00 | Per custom pallet

CONFERENCE TABLES

**Benton**

CONFIGURE & PRICE

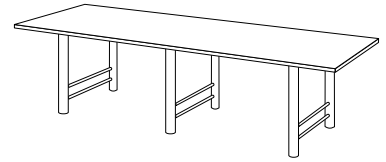

	MODEL NUMBER	SIZE	HPL	WOOD VENEER	1-DAY	5-DAY
Rectangle	BNTN-3660-RT	36 x 60	1,263	2,688	-	-
	BNTN-3666-RT	36 x 66	1,423	2,937	-	-
	BNTN-3672-RT	36 x 72	1,620	3,299	-	-
	BNTN-3678-RT	36 x 78	1,788	3,558	-	-
	BNTN-3684-RT	36 x 84	1,908	3,805	-	-
	BNTN-3696-RT	36 x 96	2,016	4,209	-	-
	BNTN-36108-RT	36 x 108	2,945	6,128	-	-
	BNTN-36120-RT	36 x 120	3,271	6,795	-	-
	BNTN-36144-RT	36 x 144	3,836	7,888	-	-
	BNTN-4278-RT	42 x 78	2,004	3,929	-	-
	BNTN-4284-RT	42 x 84	2,292	4,356	-	-
	BNTN-4296-RT	42 x 96	2,484	4,880	-	-
	BNTN-42108-RT	42 x 108	3,335	6,716	-	-
	BNTN-42120-RT	42 x 120	3,562	7,333	-	-
	BNTN-42144-RT	42 x 144	4,289	8,634	-	-
	BNTN-4884-RT	48 x 84	2,397	4,822	-	-
	BNTN-4896-RT	48 x 96	2,560	5,363	-	-
	BNTN-48108-RT	48 x 108	3,602	7,440	-	-
BNTN-48120-RT	48 x 120	3,900	8,177	-	-	
BNTN-48144-RT	48 x 144	4,569	9,515	-	-	
Racetrack	BNTN-3660-RC	36 x 60	1,683	-	-	-
	BNTN-3666-RC	36 x 66	1,801	-	-	-
	BNTN-3672-RC	36 x 72	1,848	3,322	-	-
	BNTN-3678-RC	36 x 78	2,063	3,561	-	-
	BNTN-3684-RC	36 x 84	2,210	3,840	-	-
	BNTN-3696-RC	36 x 96	2,433	4,369	-	-
	BNTN-36108-RC	36 x 108	3,285	6,148	-	-
	BNTN-36120-RC	36 x 120	3,695	7,362	-	-
	BNTN-36144-RC	36 x 144	4,393	8,170	-	-
	BNTN-4278-RC	42 x 78	2,304	3,919	-	-
	BNTN-4284-RC	42 x 84	2,667	4,482	-	-
	BNTN-4296-RC	42 x 96	2,906	5,062	-	-
	BNTN-42108-RC	42 x 108	3,704	6,790	-	-

CONFERENCE TABLES

**Benton**

**CONFIGURE & PRICE**

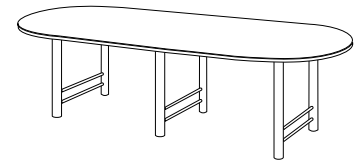

	MODEL NUMBER	SIZE	HPL	WOOD VENEER	1-DAY	5-DAY
<b>Racetrack</b>	BNTN-42120-RC	42 x 120	3,936	7,419	-	-
	BNTN-42144-RC	42 x 144	4,870	8,964	-	-
	BNTN-4884-RC	48 x 84	2,796	4,977	-	-
	BNTN-4896-RC	48 x 96	3,089	5,662	-	-
	BNTN-48108-RC	48 x 108	4,037	7,587	-	-
	BNTN-48120-RC	48 x 120	4,503	8,502	-	-
	BNTN-48144-RC	48 x 144	5,218	9,921	-	-
<b>Boat Shape</b>	BNTN-3660-BT	36 x 60	1,725	-	-	-
	BNTN-3666-BT	36 x 66	1,844	-	-	-
	BNTN-3672-BT	36 x 72	1,892	3,517	-	-
	BNTN-3684-BT	36 x 84	2,269	4,048	-	-
	BNTN-3696-BT	36 x 96	2,497	4,584	-	-
	BNTN-36108-BT	36 x 108	2,984	5,998	-	-
	BNTN-36120-BT	36 x 120	3,696	7,064	-	-
	BNTN-36144-BT	36 x 144	4,457	8,384	-	-
	BNTN-4278-BT	42 x 78	2,368	4,090	-	-
	BNTN-4284-BT	42 x 84	2,738	4,656	-	-
	BNTN-4296-BT	42 x 96	2,987	5,244	-	-
	BNTN-42108-BT	42 x 108	3,798	6,973	-	-
	BNTN-42120-BT	42 x 120	4,035	7,605	-	-
	BNTN-42144-BT	42 x 144	4,994	9,158	-	-
	BNTN-4884-BT	48 x 84	2,874	5,201	-	-
	BNTN-4896-BT	48 x 96	3,179	5,899	-	-
	BNTN-48108-BT	48 x 108	4,143	7,839	-	-
	BNTN-48120-BT	48 x 120	4,619	8,764	-	-
BNTN-48144-BT	48 x 144	5,359	10,208	-	-	
<b>Oval</b>	BNTN-3660-OV	36 x 60	1,841	-	-	-
	BNTN-3666-OV	36 x 66	1,977	-	-	-
	BNTN-3672-OV	36 x 72	2,120	3,654	-	-
	BNTN-3684-OV	36 x 84	2,449	4,140	-	-
	BNTN-3696-OV	36 x 96	2,693	4,693	-	-
	BNTN-36108-OV	36 x 108	3,212	6,136	-	-
	BNTN-36120-OV	36 x 120	3,976	7,258	-	-

## CONFERENCE TABLES

### Benton

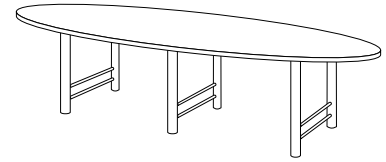

CONFIGURE & PRICE

	MODEL NUMBER	SIZE	HPL	WOOD VENEER	1-DAY	5-DAY
Oval	BNTN-36144-OV	36 x 144	4,793	8,641	-	-
	BNTN-4278-OV	42 x 78	2,546	4,206	-	-
	BNTN-4284-OV	42 x 84	2,963	4,821	-	-
	BNTN-4296-OV	42 x 96	3,241	5,445	-	-
	BNTN-42108-OV	42 x 108	4,074	7,203	-	-
	BNTN-42120-OV	42 x 120	4,336	7,867	-	-
	BNTN-42144-OV	42 x 144	5,368	9,513	-	-
	BNTN-4884-OV	48 x 84	3,117	5,330	-	-
	BNTN-4896-OV	48 x 96	3,440	6,044	-	-
	BNTN-48108-OV	48 x 108	4,459	8,034	-	-
	BNTN-48120-OV	48 x 120	4,981	9,006	-	-
	BNTN-48144-OV	48 x 144	5,778	10,513	-	-

### Benton Options

DESCRIPTION	ADD-ON
2 Piece Tabletop Standard for sizes over 108"	-
1 Piece Tabletop for sizes up to 168"	586

### Accessories for Conference Tables

OPTION	DESCRIPTION	PRICE
Grommet	Round or Rectangle	Visit SpecialT.net
Power & Data Management	Burele, EZ Power, Interact G2, Cove, Oasis, Stafford, Villa, Qi Wireless Charger	
Wire Management	Loop Clips, Velcro Loop, Cable Grip, J-shape Wire Channel, Snap Wire Channel, Wire Trough, Wire Tray, Metal Snap-On, 1" Wire Channel, Leg Clip, Adjustable Spine	
Chairs	Task, Stacking, Flipper, Sled	

\*An Oversize Fee has been implemented by freight carriers for all LTL shipments for pallets 8' and over.  
96"-108" - additional 250.00 | 109"-168" - additional 350.00 | Per custom pallet

CONFERENCE TABLES

**Connect**

**CONFIGURE & PRICE**

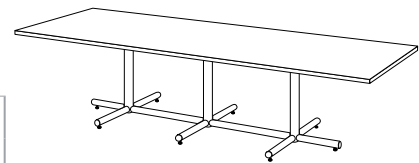

	MODEL NUMBER	SIZE	HPL	WOOD VENEER	1-DAY	5-DAY
Rectangle	CNCT-3660-RT	36 x 60	1,626	3,051	-	-
	CNCT-3666-RT	36 x 66	1,701	3,215	-	-
	CNCT-3672-RT	36 x 72	1,753	3,432	-	-
	CNCT-3678-RT	36 x 78	1,922	3,692	-	-
	CNCT-3684-RT	36 x 84	2,039	3,936	-	-
	CNCT-3696-RT	36 x 96	2,500	4,693	-	-
	CNCT-36108-RT	36 x 108	3,146	6,329	-	-
	CNCT-36120-RT	36 x 120	3,471	6,995	-	-
	CNCT-36144-RT	36 x 144	4,098	8,150	-	-
	CNCT-4278-RT	42 x 78	2,046	3,971	-	-
	CNCT-4284-RT	42 x 84	2,332	4,396	-	-
	CNCT-4296-RT	42 x 96	2,882	5,278	-	-
	CNCT-42108-RT	42 x 108	3,402	6,783	-	-
	CNCT-42120-RT	42 x 120	3,624	7,395	-	-
	CNCT-42144-RT	42 x 144	4,376	8,721	-	-
	CNCT-4884-RT	48 x 84	2,438	4,863	-	-
	CNCT-4896-RT	48 x 96	2,956	5,759	-	-
	CNCT-48108-RT	48 x 108	3,668	7,506	-	-
CNCT-48120-RT	48 x 120	3,964	8,241	-	-	
CNCT-48144-RT	48 x 144	4,659	9,605	-	-	
Race-track	CNCT-3660-RC	36 x 60	1,817	-	-	-
	CNCT-3666-RC	36 x 66	1,936	-	-	-
	CNCT-3672-RC	36 x 72	1,980	3,454	-	-
	CNCT-3678-RC	36 x 78	2,195	3,693	-	-
	CNCT-3684-RC	36 x 84	2,341	3,971	-	-
	CNCT-3696-RC	36 x 96	2,919	4,855	-	-
	CNCT-36108-RC	36 x 108	3,481	6,344	-	-
	CNCT-36120-RC	36 x 120	3,893	7,560	-	-
	CNCT-36144-RC	36 x 144	4,659	8,436	-	-
	CNCT-4278-RC	42 x 78	2,349	3,964	-	-
	CNCT-4284-RC	42 x 84	2,709	4,524	-	-
	CNCT-4296-RC	42 x 96	3,300	5,456	-	-
	CNCT-42108-RC	42 x 108	3,772	6,858	-	-
	CNCT-42120-RC	42 x 120	4,001	7,484	-	-

CONFERENCE TABLES

**Connect**

**CONFIGURE & PRICE**

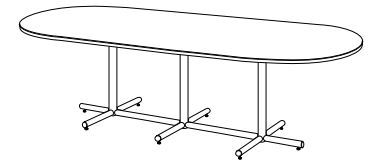

	MODEL NUMBER	SIZE	HPL	WOOD VENEER	1-DAY	5-DAY
<b>Racetrack</b>	CNCT-42144-RC	42 x 144	4,958	9,052	-	-
	CNCT-4884-RC	48 x 84	2,840	5,021	-	-
	CNCT-4896-RC	48 x 96	3,486	6,059	-	-
	CNCT-48108-RC	48 x 108	4,105	7,655	-	-
	CNCT-48120-RC	48 x 120	4,567	8,566	-	-
	CNCT-48144-RC	48 x 144	5,307	10,010	-	-
<b>Boat Shape</b>	CNCT-3660-BT	36 x 60	1,858	-	-	-
	CNCT-3666-BT	36 x 66	1,978	-	-	-
	CNCT-3672-BT	36 x 72	2,027	3,652	-	-
	CNCT-3684-BT	36 x 84	2,400	4,179	-	-
	CNCT-3696-BT	36 x 96	2,629	4,716	-	-
	CNCT-36108-BT	36 x 108	3,470	6,484	-	-
	CNCT-36120-BT	36 x 120	3,897	7,265	-	-
	CNCT-36144-BT	36 x 144	4,723	8,650	-	-
	CNCT-4278-BT	42 x 78	2,409	4,131	-	-
	CNCT-4284-BT	42 x 84	2,783	4,701	-	-
	CNCT-4296-BT	42 x 96	3,384	5,641	-	-
	CNCT-42108-BT	42 x 108	3,864	7,039	-	-
	CNCT-42120-BT	42 x 120	4,098	7,668	-	-
	CNCT-42144-BT	42 x 144	5,080	9,244	-	-
	CNCT-4884-BT	48 x 84	2,920	5,247	-	-
	CNCT-4896-BT	48 x 96	3,575	6,295	-	-
	CNCT-48108-BT	48 x 108	4,208	7,904	-	-
	CNCT-48120-BT	48 x 120	4,686	8,831	-	-
CNCT-48144-BT	48 x 144	5,447	10,296	-	-	
<b>Oval</b>	CNCT-3660-OV	36 x 60	1,974	-	-	-
	CNCT-3666-OV	36 x 66	2,109	-	-	-
	CNCT-3672-OV	36 x 72	2,252	3,786	-	-
	CNCT-3684-OV	36 x 84	2,581	4,272	-	-
	CNCT-3696-OV	36 x 96	2,826	4,826	-	-
	CNCT-36108-OV	36 x 108	3,698	6,622	-	-
	CNCT-36120-OV	36 x 120	4,177	7,459	-	-
	CNCT-36144-OV	36 x 144	5,056	8,904	-	-

CONFERENCE TABLES

**Connect**

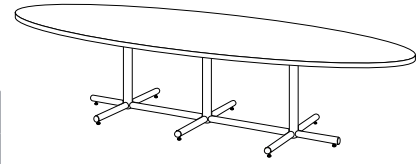

**CONFIGURE & PRICE**

	MODEL NUMBER	SIZE	HPL	WOOD VENEER	1-DAY	5-DAY
Oval	CNCT-4278-OV	42 x 78	2,590	4,250	-	-
	CNCT-4284-OV	42 x 84	3,008	4,866	-	-
	CNCT-4296-OV	42 x 96	3,640	5,844	-	-
	CNCT-42108-OV	42 x 108	4,140	7,269	-	-
	CNCT-42120-OV	42 x 120	4,402	7,933	-	-
	CNCT-42144-OV	42 x 144	5,458	9,603	-	-
	CNCT-4884-OV	48 x 84	3,161	5,374	-	-
	CNCT-4896-OV	48 x 96	3,838	6,442	-	-
	CNCT-48108-OV	48 x 108	4,524	8,099	-	-
	CNCT-48120-OV	48 x 120	5,047	9,072	-	-
	CNCT-48144-OV	48 x 144	5,866	10,601	-	-

**Connect Options**

MODEL NUMBER	DESCRIPTION	ADD-ON		
		UP TO 84" LONG	96" - 120" LONG	144" LONG
-BH	Bar Height 42"	126	189	252
-CA	Casters	114	152	190
-SLG	Self Leveling Glides	126	168	210
		UP TO 96" LONG		108" - 144" LONG
	2 Piece Tabletop Standard for sizes over 108"	-		-
	1 Piece Tabletop for sizes 108" to 168"	-		586

**Accessories for Conference Tables**

OPTION	DESCRIPTION	PRICE
Grommet	Round or Rectangle	Visit SpecialT.net
Power & Data Management	Burele, EZ Power, Interact G2, Cove, Oasis, Stafford, Villa, Qi Wireless Charger	
Wire Management	Loop Clips, Velcro Loop, Cable Grip, J-shape Wire Channel, Snap Wire Channel, Wire Trough, Wire Tray, 1" Wire Channel, Metal Snap-On, Leg Clip, Adjustable Spine	
Chairs	Task, Stacking, Flipper, Sled	

\*An Oversize Fee has been implemented by freight carriers for all LTL shipments for pallets 8' and over.  
96"-108" - additional 250.00 | 109"-168" - additional 350.00 | Per custom pallet

CONFERENCE TABLES

**Olympus**

CONFIGURE & PRICE

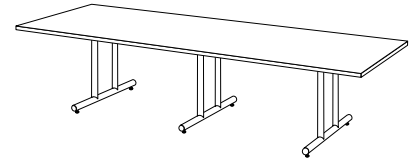

	MODEL NUMBER	SIZE	HPL	WOOD VENEER	1-DAY	5-DAY
Rectangle	OLYM-3660-RT	36 x 60	1,381	2,806	-	-
	OLYM-3666-RT	36 x 66	1,542	3,056	-	-
	OLYM-3672-RT	36 x 72	1,665	3,344	-	-
	OLYM-3678-RT	36 x 78	1,833	3,603	-	-
	OLYM-3684-RT	36 x 84	1,951	3,848	-	-
	OLYM-3696-RT	36 x 96	2,061	4,254	-	-
	OLYM-36108-RT	36 x 108	3,011	6,194	-	-
	OLYM-36120-RT	36 x 120	3,340	6,864	-	-
	OLYM-36144-RT	36 x 144	3,924	7,976	-	-
	OLYM-4278-RT	42 x 78	2,010	3,935	-	-
	OLYM-4284-RT	42 x 84	2,299	4,363	-	-
	OLYM-4296-RT	42 x 96	2,491	4,887	-	-
	OLYM-42108-RT	42 x 108	3,349	6,730	-	-
	OLYM-42120-RT	42 x 120	3,575	7,346	-	-
	OLYM-42144-RT	42 x 144	4,306	8,651	-	-
	OLYM-4884-RT	48 x 84	2,449	4,874	-	-
	OLYM-4896-RT	48 x 96	2,612	5,415	-	-
	OLYM-48108-RT	48 x 108	3,680	7,518	-	-
	OLYM-48120-RT	48 x 120	3,982	8,259	-	-
	OLYM-48144-RT	48 x 144	4,673	9,619	-	-
OLYM-6096-RT	60 x 96	3,335	6,751	-	-	
OLYM-60108-RT	60 x 108	4,074	8,568	-	-	
OLYM-60120-RT	60 x 120	4,809	9,838	-	-	
OLYM-60144-RT	60 x 144	5,455	11,295	-	-	
Race-track	OLYM-3660-RC	36 x 60	1,727	-	-	-
	OLYM-3666-RC	36 x 66	1,844	-	-	-
	OLYM-3672-RC	36 x 72	1,892	3,366	-	-
	OLYM-3678-RC	36 x 78	2,108	3,606	-	-
	OLYM-3684-RC	36 x 84	2,254	3,884	-	-
	OLYM-3696-RC	36 x 96	2,474	4,410	-	-
	OLYM-36108-RC	36 x 108	3,349	6,212	-	-
	OLYM-36120-RC	36 x 120	3,759	7,426	-	-
	OLYM-36144-RC	36 x 144	4,481	8,258	-	-
	OLYM-4278-RC	42 x 78	2,315	3,930	-	-



CONFERENCE TABLES

**Olympus**

CONFIGURE & PRICE

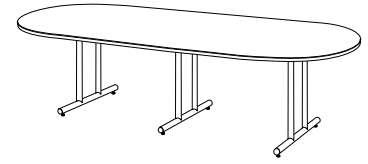

	MODEL NUMBER	SIZE	HPL	WOOD VENEER	1-DAY	5-DAY
Racetrack	OLYM-4284-RC	42 x 84	2,675	4,490	-	-
	OLYM-4296-RC	42 x 96	2,914	5,070	-	-
	OLYM-42108-RC	42 x 108	3,718	6,804	-	-
	OLYM-42120-RC	42 x 120	3,947	7,430	-	-
	OLYM-42144-RC	42 x 144	4,886	8,980	-	-
	OLYM-4884-RC	48 x 84	2,849	5,030	-	-
	OLYM-4896-RC	48 x 96	3,141	5,714	-	-
	OLYM-48108-RC	48 x 108	4,117	7,667	-	-
	OLYM-48120-RC	48 x 120	4,580	8,579	-	-
	OLYM-48144-RC	48 x 144	5,326	10,029	-	-
	OLYM-6096-RC	60 x 96	3,940	7,068	-	-
	OLYM-60108-RC	60 x 108	4,679	8,830	-	-
	OLYM-60120-RC	60 x 120	5,498	10,194	-	-
	OLYM-60144-RC	60 x 144	6,266	11,810	-	-
Boat Shape	OLYM-3660-BT	36 x 60	1,768	-	-	-
	OLYM-3666-BT	36 x 66	1,889	-	-	-
	OLYM-3672-BT	36 x 72	1,940	3,565	-	-
	OLYM-3684-BT	36 x 84	2,314	4,093	-	-
	OLYM-3696-BT	36 x 96	2,544	4,631	-	-
	OLYM-36108-BT	36 x 108	3,029	6,043	-	-
	OLYM-36120-BT	36 x 120	3,760	7,128	-	-
	OLYM-36144-BT	36 x 144	4,657	8,584	-	-
	OLYM-4278-BT	42 x 78	2,376	4,098	-	-
	OLYM-4284-BT	42 x 84	2,748	4,666	-	-
	OLYM-4296-BT	42 x 96	2,998	5,255	-	-
	OLYM-42108-BT	42 x 108	3,809	6,984	-	-
	OLYM-42120-BT	42 x 120	4,047	7,617	-	-
	OLYM-42144-BT	42 x 144	5,012	9,176	-	-
	OLYM-4884-BT	48 x 84	2,929	5,256	-	-
	OLYM-4896-BT	48 x 96	3,233	5,953	-	-
	OLYM-48108-BT	48 x 108	4,219	7,915	-	-
	OLYM-48120-BT	48 x 120	4,699	8,844	-	-
	OLYM-48144-BT	48 x 144	5,462	10,311	-	-
	OLYM-6096-BT	60 x 96	4,064	7,338	-	-

CONFERENCE TABLES

**Olympus**

CONFIGURE & PRICE

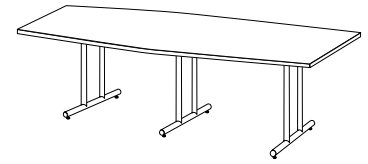

	MODEL NUMBER	SIZE	HPL	WOOD VENEER	1-DAY	5-DAY
Boat Shape	OLYM-60108-BT	60 x 108	4,818	9,115	-	-
	OLYM-60120-BT	60 x 120	5,652	10,495	-	-
	OLYM-60144-BT	60 x 144	6,439	12,130	-	-
Oval	OLYM-3660-OV	36 x 60	1,886	-	-	-
	OLYM-3666-OV	36 x 66	2,018	-	-	-
	OLYM-3672-OV	36 x 72	2,163	3,697	-	-
	OLYM-3684-OV	36 x 84	2,493	4,184	-	-
	OLYM-3696-OV	36 x 96	2,738	4,738	-	-
	OLYM-36108-OV	36 x 108	3,259	6,183	-	-
	OLYM-36120-OV	36 x 120	4,045	7,327	-	-
	OLYM-36144-OV	36 x 144	4,992	8,840	-	-
	OLYM-4278-OV	42 x 78	2,554	4,214	-	-
	OLYM-4284-OV	42 x 84	2,973	4,831	-	-
	OLYM-4296-OV	42 x 96	3,251	5,455	-	-
	OLYM-42108-OV	42 x 108	4,088	7,217	-	-
	OLYM-42120-OV	42 x 120	4,351	7,882	-	-
	OLYM-42144-OV	42 x 144	5,387	9,532	-	-
	OLYM-4884-OV	48 x 84	3,167	5,380	-	-
	OLYM-4896-OV	48 x 96	3,493	6,097	-	-
	OLYM-48108-OV	48 x 108	4,539	8,114	-	-
	OLYM-48120-OV	48 x 120	5,062	9,087	-	-
	OLYM-48144-OV	48 x 144	5,883	10,618	-	-
	OLYM-6096-OV	60 x 96	4,426	7,558	-	-
OLYM-60108-OV	60 x 108	5,236	9,387	-	-	
OLYM-60120-OV	60 x 120	6,118	10,813	-	-	
OLYM-60144-OV	60 x 144	6,952	11,838	-	-	

CONFERENCE TABLES  
**Olympus Options**

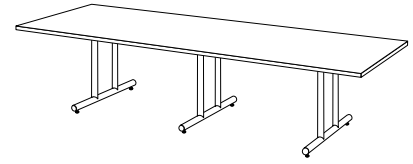

MODEL NUMBER	DESCRIPTION	ADD-ON	
		UP TO 96" LONG	108" - 144" LONG
-BH	Bar Height 42"	252	378
-CA	Casters	76	114
2 Piece Tabletop Standard for sizes over 108"		-	-
1 Piece Tabletop for sizes 108" to 168"		-	586

**Accessories for Conference Tables**

OPTION	DESCRIPTION	PRICE
Grommet	Round or Rectangle	Visit SpecialT.net
Power & Data Management	Burele, EZ Power, Interact G2, Cove, Oasis, Stafford, Villa, Qi Wireless Charger	
Wire Management	Loop Clips, Velcro Loop, Cable Grip, J-shape Wire Channel, Snap Wire Channel, Wire Trough, Wire Tray, 1" Wire Channel, Adjustable Spine	
Chairs	Task, Stacking, Flipper, Sled	

\*An Oversize Fee has been implemented by freight carriers for all LTL shipments for pallets 8' and over.  
 96"-108" - additional 250.00 | 109" -168" - additional 350.00 | Per custom pallet

CONFERENCE TABLES

**Oscar**

CONFIGURE & PRICE

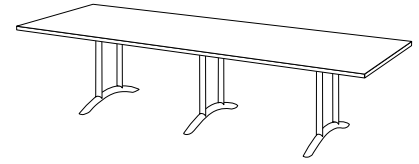

	MODEL NUMBER	SIZE	HPL	WOOD VENEER	1-DAY	5-DAY
Rectangle	OSCR-3660-RT	36 x 60	1,438	2,863	-	-
	OSCR-3666-RT	36 x 66	1,606	3,120	-	-
	OSCR-3672-RT	36 x 72	1,659	3,338	-	-
	OSCR-3678-RT	36 x 78	1,832	3,602	-	-
	OSCR-3684-RT	36 x 84	1,886	3,783	-	-
	OSCR-3696-RT	36 x 96	1,995	4,188	-	-
	OSCR-36108-RT	36 x 108	2,913	6,096	-	-
	OSCR-36120-RT	36 x 120	3,239	6,763	-	-
	OSCR-36144-RT	36 x 144	3,514	7,566	-	-
	OSCR-4278-RT	42 x 78	1,958	3,883	-	-
	OSCR-4284-RT	42 x 84	2,246	4,310	-	-
	OSCR-4296-RT	42 x 96	2,438	4,834	-	-
	OSCR-42108-RT	42 x 108	2,961	6,342	-	-
	OSCR-42120-RT	42 x 120	3,498	7,269	-	-
	OSCR-42144-RT	42 x 144	3,892	8,237	-	-
	OSCR-4884-RT	48 x 84	2,375	4,800	-	-
	OSCR-4896-RT	48 x 96	2,538	5,341	-	-
	OSCR-48108-RT	48 x 108	3,248	7,086	-	-
	OSCR-48120-RT	48 x 120	3,548	7,825	-	-
	OSCR-48144-RT	48 x 144	4,262	9,208	-	-
Racetrack	OSCR-3660-RC	36 x 60	1,865	-	-	-
	OSCR-3666-RC	36 x 66	1,979	-	-	-
	OSCR-3672-RC	36 x 72	2,028	3,502	-	-
	OSCR-3678-RC	36 x 78	2,242	3,740	-	-
	OSCR-3684-RC	36 x 84	2,387	4,017	-	-
	OSCR-3696-RC	36 x 96	2,409	4,345	-	-
	OSCR-36108-RC	36 x 108	3,451	6,314	-	-
	OSCR-36120-RC	36 x 120	3,863	7,530	-	-
	OSCR-36144-RC	36 x 144	4,273	8,050	-	-
	OSCR-4278-RC	42 x 78	2,461	4,076	-	-
	OSCR-4284-RC	42 x 84	2,822	4,637	-	-
	OSCR-4296-RC	42 x 96	3,064	5,220	-	-
	OSCR-42108-RC	42 x 108	3,530	6,616	-	-

CONFERENCE TABLES

**Oscar**

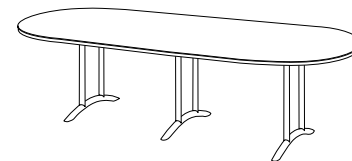

CONFIGURE & PRICE

	MODEL NUMBER	SIZE	HPL	WOOD VENEER	1-DAY	5-DAY
<b>Racetrack</b>	OSCR-42120-RC	42 x 120	4,069	7,552	-	-
	OSCR-42144-RC	42 x 144	4,673	8,767	-	-
	OSCR-4884-RC	48 x 84	2,975	5,156	-	-
	OSCR-4896-RC	48 x 96	3,066	5,639	-	-
	OSCR-48108-RC	48 x 108	3,886	7,436	-	-
	OSCR-48120-RC	48 x 120	4,151	8,150	-	-
	OSCR-48144-RC	48 x 144	4,856	9,559	-	-
<b>Boat Shape</b>	OSCR-3660-BT	36 x 60	1,702	-	-	-
	OSCR-3666-BT	36 x 66	1,823	-	-	-
	OSCR-3672-BT	36 x 72	1,870	3,495	-	-
	OSCR-3684-BT	36 x 84	2,446	4,225	-	-
	OSCR-3696-BT	36 x 96	2,474	4,561	-	-
	OSCR-36108-BT	36 x 108	3,359	6,373	-	-
	OSCR-36120-BT	36 x 120	4,146	7,514	-	-
	OSCR-36144-BT	36 x 144	4,673	8,600	-	-
	OSCR-4278-BT	42 x 78	2,522	4,244	-	-
	OSCR-4284-BT	42 x 84	2,896	4,814	-	-
	OSCR-4296-BT	42 x 96	3,146	5,403	-	-
	OSCR-42108-BT	42 x 108	3,622	6,797	-	-
	OSCR-42120-BT	42 x 120	4,169	7,739	-	-
	OSCR-42144-BT	42 x 144	4,799	8,963	-	-
	OSCR-4884-BT	48 x 84	3,055	5,382	-	-
	OSCR-4896-BT	48 x 96	3,156	5,876	-	-
	OSCR-48108-BT	48 x 108	3,990	7,686	-	-
	OSCR-48120-BT	48 x 120	4,265	8,410	-	-
	OSCR-48144-BT	48 x 144	4,994	9,843	-	-
<b>Oval</b>	OSCR-3660-OV	36 x 60	2,023	-	-	-
	OSCR-3666-OV	36 x 66	2,155	-	-	-
	OSCR-3672-OV	36 x 72	2,099	3,633	-	-
	OSCR-3684-OV	36 x 84	2,628	4,319	-	-
	OSCR-3696-OV	36 x 96	2,671	4,671	-	-
	OSCR-36108-OV	36 x 108	3,467	6,391	-	-
	OSCR-36120-OV	36 x 120	4,278	7,560	-	-

## CONFERENCE TABLES

### Oscar

CONFIGURE & PRICE

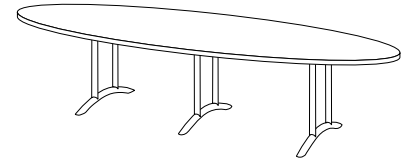

	MODEL NUMBER	SIZE	HPL	WOOD VENEER	1-DAY	5-DAY
Oval	OSCR-36144-OV	36 x 144	4,828	8,676	-	-
	OSCR-4278-OV	42 x 78	2,702	4,362	-	-
	OSCR-4284-OV	42 x 84	3,120	4,978	-	-
	OSCR-4296-OV	42 x 96	3,402	5,606	-	-
	OSCR-42108-OV	42 x 108	3,900	7,029	-	-
	OSCR-42120-OV	42 x 120	4,375	7,906	-	-
	OSCR-42144-OV	42 x 144	5,066	9,211	-	-
	OSCR-4884-OV	48 x 84	3,094	5,307	-	-
	OSCR-4896-OV	48 x 96	3,419	6,023	-	-
	OSCR-48108-OV	48 x 108	4,106	7,681	-	-
	OSCR-48120-OV	48 x 120	4,626	8,651	-	-
	OSCR-48144-OV	48 x 144	5,415	10,150	-	-

### Oscar Options

DESCRIPTION	ADD-ON
2 Piece Tabletop Standard for sizes over 108"	-
1 Piece Tabletop for sizes up to 168"	586

### Accessories for Conference Tables

OPTION	DESCRIPTION	PRICE
Grommet	Round or Rectangle	Visit SpecialT.net
Power & Data Management	Burele, EZ Power, Interact G2, Cove, Oasis, Stafford, Villa, Qi Wireless Charger	
Wire Management	Loop Clips, Velcro Loop, Cable Grip, J-shape Wire Channel, Snap Wire Channel, Wire Trough, Wire Tray, 1" Wire Channel, Metal Snap-On, Leg Clip, Adjustable Spine	
Chairs	Task, Stacking, Flipper, Sled	

\*An Oversize Fee has been implemented by freight carriers for all LTL shipments for pallets 8' and over.  
96"-108" - additional 250.00 | 109"-168" - additional 350.00 | Per custom pallet

CONFERENCE TABLES  
**Sienna Conference**

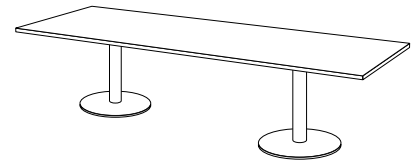

CONFIGURE & PRICE

	MODEL NUMBER	SIZE	HPL	WOOD VENEER	1-DAY	5-DAY
Rectangle	SIEN-2460-RT	24 x 60	1,590	2,615	-	-
	SIEN-2472-RT	24 x 72	1,703	2,915	-	-
	SIEN-2484-RT	24 x 84	1,848	3,219	-	-
	SIEN-2496-RT	24 x 96	1,979	3,562	-	-
	SIEN-24108-RT	24 x 108	2,868	5,393	-	-
	SIEN-24120-RT	24 x 120	2,900	5,672	-	-
	SIEN-3060-RT	30 x 60	1,954	3,303	-	-
	SIEN-3072-RT	30 x 72	2,071	3,661	-	-
	SIEN-3084-RT	30 x 84	2,233	4,365	-	-
	SIEN-3096-RT	30 x 96	2,381	5,681	-	-
	SIEN-30108-RT	30 x 108	2,876	6,339	-	-
	SIEN-30120-RT	30 x 120	3,446	3,446	-	-
	SIEN-3660-RT	36 x 60	2,317	3,742	-	-
	SIEN-3672-RT	36 x 72	2,451	4,130	-	-
	SIEN-3684-RT	36 x 84	2,638	4,535	-	-
	SIEN-3696-RT	36 x 96	2,796	4,989	-	-
	SIEN-36108-RT	36 x 108	3,325	6,508	-	-
	SIEN-36120-RT	36 x 120	3,347	6,871	-	-
	SIEN-36144-RT	36 x 144	4,288	8,340	-	-
	SIEN-4284-RT	42 x 84	2,922	4,986	-	-
SIEN-4296-RT	42 x 96	3,099	5,495	-	-	
SIEN-42108-RT	42 x 108	3,699	7,080	-	-	
SIEN-42120-RT	42 x 120	3,724	7,495	-	-	
SIEN-42144-RT	42 x 144	4,735	9,080	-	-	
Racetrack	SIEN-2460-RC	24 x 60	1,758	-	-	-
	SIEN-2472-RC	24 x 72	1,885	-	-	-
	SIEN-2484-RC	24 x 84	2,026	-	-	-
	SIEN-2496-RC	24 x 96	2,139	-	-	-
	SIEN-24108-RC	24 x 108	3,064	-	-	-
	SIEN-24120-RC	24 x 120	3,072	-	-	-
	SIEN-3060-RC	30 x 60	2,192	-	-	-
	SIEN-3072-RC	30 x 72	2,288	-	-	-
	SIEN-3084-RC	30 x 84	2,474	-	-	-
	SIEN-3096-RC	30 x 96	2,580	-	-	-

CONFERENCE TABLES  
**Sienna Conference**

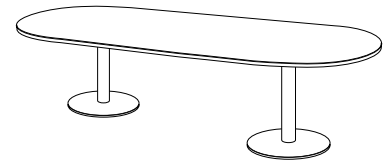

**CONFIGURE & PRICE**

	MODEL NUMBER	SIZE	HPL	WOOD VENEER	1-DAY	5-DAY
Racetrack	SIEN-30108-RC	30 x 108	3,331	-	-	-
	SIEN-30120-RC	30 x 120	3,749	-	-	-
	SIEN-3660-RC	36 x 60	2,317	-	-	-
	SIEN-3672-RC	36 x 72	2,451	3,925	-	-
	SIEN-3684-RC	36 x 84	2,638	4,268	-	-
	SIEN-3696-RC	36 x 96	2,796	4,732	-	-
	SIEN-36108-RC	36 x 108	3,325	6,188	-	-
	SIEN-36120-RC	36 x 120	3,347	7,014	-	-
	SIEN-36144-RC	36 x 144	4,288	8,065	-	-
	SIEN-4284-RC	42 x 84	2,922	4,737	-	-
	SIEN-4296-RC	42 x 96	3,099	5,255	-	-
	SIEN-42108-RC	42 x 108	3,699	6,785	-	-
	SIEN-42120-RC	42 x 120	3,724	7,207	-	-
	SIEN-42144-RC	42 x 144	4,735	8,829	-	-
Boat Shape	SIEN-2460-BT	24 x 60	1,590	-	-	-
	SIEN-2472-BT	24 x 72	1,703	-	-	-
	SIEN-2484-BT	24 x 84	1,848	-	-	-
	SIEN-2496-BT	24 x 96	1,979	-	-	-
	SIEN-24108-BT	24 x 108	2,868	-	-	-
	SIEN-24120-BT	24 x 120	2,900	-	-	-
	SIEN-3060-BT	30 x 60	1,954	-	-	-
	SIEN-3072-BT	30 x 72	2,071	-	-	-
	SIEN-3084-BT	30 x 84	2,233	-	-	-
	SIEN-3096-BT	30 x 96	2,381	-	-	-
	SIEN-30108-BT	30 x 108	2,876	-	-	-
	SIEN-30120-BT	30 x 120	3,446	-	-	-
	SIEN-3660-BT	36 x 60	2,317	-	-	-
	SIEN-3672-BT	36 x 72	2,451	4,076	-	-
	SIEN-3684-BT	36 x 84	2,638	4,417	-	-
	SIEN-3696-BT	36 x 96	2,796	4,883	-	-
	SIEN-36108-BT	36 x 108	3,325	6,339	-	-
	SIEN-36120-BT	36 x 120	3,347	6,715	-	-
SIEN-36144-BT	36 x 144	4,288	8,215	-	-	



CONFERENCE TABLES

**Sienna Conference**

**CONFIGURE & PRICE**

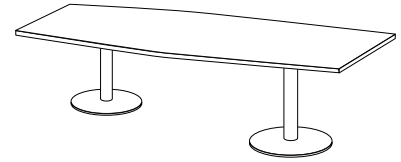

	MODEL NUMBER	SIZE	HPL	WOOD VENEER	1-DAY	5-DAY
<b>Boat Shape</b>	SIEN-4284-BT	42 x 84	2,922	4,840	-	-
	SIEN-4296-BT	42 x 96	3,099	5,356	-	-
	SIEN-42108-BT	42 x 108	3,699	6,874	-	-
	SIEN-42120-BT	42 x 120	3,724	7,294	-	-
	SIEN-42144-BT	42 x 144	4,735	8,899	-	-

**Accessories for Conference Tables**

MODEL NUMBER	DESCRIPTION	ADD-ON
-BH	Bar Height	126
-CUSTHT1	Custom Height between 5" - 28.99"	136
-CUSTHT2	Custom Height between 29" - 42"	262
2 Piece Tabletop Standard for sizes over 108"		-
1 Piece Tabletop for sizes up to 168"		586

**Accessories for Conference Tables**

OPTION	DESCRIPTION	PRICE
Grommet	Round or Rectangle	Visit SpecialT.net
Power & Data Management	Burele, EZ Power, Interact G2, Cove, Oasis, Stafford, Villa, Qi Wireless Charger	
Wire Management	Loop Clips, Velcro Loop, Cable Grip, J-shape Wire Channel, Snap Wire Channel, Wire Trough, Wire Tray, 1" Wire Channel, Metal Snap-On, Leg Clip, Adjustable Spine	
Chairs	Task, Stacking, Flipper, Sled	

\*An Oversize Fee has been implemented by freight carriers for all LTL shipments for pallets 8' and over.  
96"-108" - additional 250.00 | 109" -168" - additional 350.00 | Per custom pallet

CONFERENCE TABLES

**Sienna 2TL**

CONFIGURE & PRICE

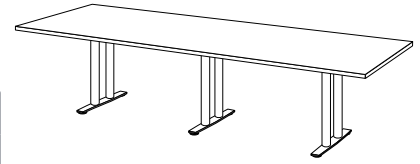

	MODEL NUMBER	SIZE	HPL	WOOD VENEER	1-DAY	5-DAY
Rectangle	SIENTL-3660-RT	36 x 60	1,848	3,273	-	-
	SIENTL-3666-RT	36 x 66	1,964	3,478	-	-
	SIENTL-3672-RT	36 x 72	1,974	3,653	-	-
	SIENTL-3678-RT	36 x 78	2,089	3,859	-	-
	SIENTL-3684-RT	36 x 84	2,228	4,125	-	-
	SIENTL-3696-RT	36 x 96	2,314	4,507	-	-
	SIENTL-36108-RT	36 x 108	3,277	6,460	-	-
	SIENTL-36120-RT	36 x 120	3,298	6,822	-	-
	SIENTL-36144-RT	36 x 144	3,468	7,520	-	-
	SIENTL-4278-RT	42 x 78	2,343	4,268	-	-
	SIENTL-4284-RT	42 x 84	2,425	4,489	-	-
	SIENTL-4296-RT	42 x 96	2,517	4,913	-	-
	SIENTL-42108-RT	42 x 108	3,624	7,005	-	-
	SIENTL-42120-RT	42 x 120	3,658	7,429	-	-
	SIENTL-42144-RT	42 x 144	3,982	8,327	-	-
	SIENTL-4884-RT	48 x 84	2,524	4,949	-	-
	SIENTL-4896-RT	48 x 96	2,568	5,371	-	-
	SIENTL-48108-RT	48 x 108	3,723	7,561	-	-
	SIENTL-48120-RT	48 x 120	3,888	8,165	-	-
SIENTL-48144-RT	48 x 144	4,085	9,031	-	-	
Racetrack	SIENTL-3660-RC	36 x 60	2,317	-	-	-
	SIENTL-3672-RC	36 x 72	2,442	3,916	-	-
	SIENTL-3684-RC	36 x 84	2,638	4,268	-	-
	SIENTL-3696-RC	36 x 96	2,796	4,732	-	-
	SIENTL-36108-RC	36 x 108	3,325	6,188	-	-
	SIENTL-36120-RC	36 x 120	3,347	7,014	-	-
	SIENTL-36144-RC	36 x 144	4,288	8,065	-	-
	SIENTL-4284-RC	42 x 84	2,957	4,772	-	-
	SIENTL-4296-RC	42 x 96	3,099	5,255	-	-
	SIENTL-42108-RC	42 x 108	3,699	6,785	-	-
	SIENTL-42120-RC	42 x 120	3,724	7,207	-	-
	SIENTL-42144-RC	42 x 144	4,735	8,829	-	-

CONFERENCE TABLES

**Sienna 2TL**

CONFIGURE & PRICE

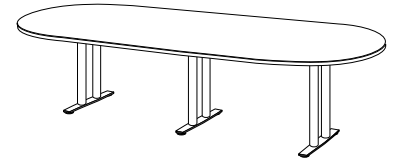

	MODEL NUMBER	SIZE	HPL	WOOD VENEER	1-DAY	5-DAY
<b>Racetrack</b>	SIENTL-4884-RC	48 x 84	2,922	5,103	-	-
	SIENTL-4896-RC	48 x 96	3,099	5,672	-	-
	SIENTL-48108-RC	48 x 108	3,699	7,249	-	-
	SIENTL-48120-RC	48 x 120	3,724	7,723	-	-
	SIENTL-48144-RC	48 x 144	4,735	9,438	-	-
<b>Boat Shape</b>	SIENTL-3660-BT	36 x 60	2,317	-	-	-
	SIENTL-3672-BT	36 x 72	2,442	4,067	-	-
	SIENTL-3684-BT	36 x 84	2,638	4,417	-	-
	SIENTL-3696-BT	36 x 96	2,796	4,883	-	-
	SIENTL-36108-BT	36 x 108	3,325	6,339	-	-
	SIENTL-36120-BT	36 x 120	3,347	6,715	-	-
	SIENTL-36144-BT	36 x 144	4,288	8,215	-	-
	SIENTL-4284-BT	42 x 84	2,957	4,875	-	-
	SIENTL-4296-BT	42 x 96	3,099	5,356	-	-
	SIENTL-42108-BT	42 x 108	3,699	6,874	-	-
	SIENTL-42120-BT	42 x 120	3,724	7,294	-	-
	SIENTL-42144-BT	42 x 144	4,735	8,899	-	-
	SIENTL-4884-BT	48 x 84	2,922	5,249	-	-
	SIENTL-4896-BT	48 x 96	3,099	5,819	-	-
	SIENTL-48108-BT	48 x 108	3,699	7,395	-	-
	SIENTL-48120-BT	48 x 120	3,724	7,869	-	-
	SIENTL-48144-BT	48 x 144	4,735	9,584	-	-

CONFERENCE TABLES

**Sienna 2TL Options**

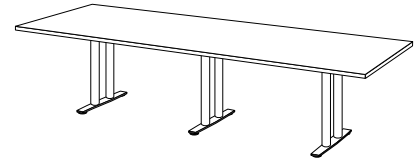

MODEL NUMBER	DESCRIPTION	ADD-ON	
		UP TO 96" LONG	108" - 144" LONG
-BH	Bar Height 42"	252	378
-SC	Skate Casters	128	192
	2 Piece Tabletop Standard for sizes over 108"	-	-
	1 Piece Tabletop for sizes up to 168"	-	586

**Accessories for Conference Tables**

OPTION	DESCRIPTION	PRICE
Grommet	Round or Rectangle	Visit SpecialT.net
Power & Data Management	Burele, EZ Power, Interact G2, Cove, Oasis, Stafford, Villa, Qi Wireless Charger	
Wire Management	Loop Clips, Velcro Loop, Cable Grip, J-shape Wire Channel, Snap Wire Channel, Wire Trough, Wire Tray, 1" Wire Channel, Metal Snap-On, Leg Clip, Adjustable Spine	
Chairs	Task, Stacking, Flipper, Sled	

\*An Oversize Fee has been implemented by freight carriers for all LTL shipments for pallets 8' and over.  
96"-108" - additional 250.00 | 109" -168" - additional 350.00 | Per custom pallet

CONFERENCE TABLES

**Sienna 4X**

CONFIGURE & PRICE

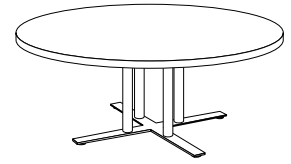

	MODEL NUMBER	SIZE	HPL	WOOD VENEER	1-DAY	5-DAY
Round	SIENX-54	54"	1,722	3,236	-	-
	SIENX-60	60"	2,362	4,341	-	-
	SIENX-66	66"	3,318	6,026	-	-
	SIENX-72	72"	3,453	6,676	-	-
Square	SIENX-5454	54 x 54	1,626	3,345	-	-
	SIENX-6060	60 x 60	2,264	4,483	-	-

**Sienna 4X Options**

MODEL NUMBER	DESCRIPTION	ADD-ON
-BH	Bar Height	252
-SLG	Self Leveling Glides	84
-SC	Skate Casters	128
-CUSTHT1	Custom Height between 5" - 28.99"	272
-CUSTHT2	Custom Height between 29" - 42"	524

**Accessories for Conference Tables**

OPTION	DESCRIPTION	PRICE
Grommet	Round or Rectangle	Visit SpecialT.net
Power & Data Management	Burele, EZ Power, Interact G2, Cove, Oasis, Stafford, Villa, Qi Wireless Charger	
Wire Management	Loop Clips, Velcro Loop, Cable Grip, J-shape Wire Channel, Snap Wire Channel, Wire Trough, Wire Tray, 1" Wire Channel, Metal Snap-On, Leg Clip, Adjustable Spine	
Chairs	Task, Stacking, Flipper, Sled	

CONFERENCE TABLES

**Sienna Rectangle**

**CONFIGURE & PRICE**

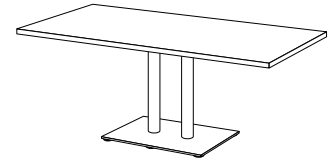

	MODEL NUMBER	SIZE	HPL	WOOD VENEER	1-DAY	5-DAY
Rectangle	SIENPL-3660-RT	36 x 60	1,872	3,297	-	-
	SIENPL-3666-RT	36 x 66	1,988	3,502	-	-
	SIENPL-3672-RT	36 x 72	1,999	3,678	-	-
	SIENPL-3678-RT	36 x 78	2,115	3,885	-	-
	SIENPL-4278-RT	42 x 78	2,369	4,294	-	-

**Sienna Rectangle Options**

MODEL NUMBER	DESCRIPTION	ADD-ON
-BH	Bar Height	126

**Accessories for Conference Tables**

OPTION	DESCRIPTION	PRICE
Grommet	Round or Rectangle	Visit SpecialT.net
Power & Data Management	Burele, EZ Power, Interact G2, Cove, Oasis, Stafford, Villa, Qi Wireless Charger	
Wire Management	Loop Clips, Velcro Loop, Cable Grip, J-shape Wire Channel, Snap Wire Channel, Wire Trough, Wire Tray, 1" Wire Channel, Metal Snap-On, Leg Clip, Adjustable Spine	
Chairs	Task, Stacking, Flipper, Sled	

CONFERENCE TABLES

**Structure 4X**

**CONFIGURE & PRICE**



	MODEL NUMBER	SIZE	HPL	WOOD VENEER	1-DAY	5-DAY
Rectangle	STRU-4X-2460-RT	24 x 60	1,683	2,708	-	1,853
	STRU-4X-2466-RT	24 x 66	1,726	2,819	-	1,900
	STRU-4X-2472-RT	24 x 72	1,776	2,988	-	1,953
	STRU-4X-2484-RT	24 x 84	1,993	3,364	-	2,192
	STRU-4X-2496-RT	24 x 96	2,213	3,796	-	2,434
	STRU-4X-3060-RT	30 x 60	1,841	3,190	-	2,024
	STRU-4X-3066-RT	30 x 66	1,879	3,312	-	2,066
	STRU-4X-3072-RT	30 x 72	1,952	3,542	-	2,147
	STRU-4X-3084-RT	30 x 84	2,291	4,134	-	2,519
	STRU-4X-3096-RT	30 x 96	2,483	4,615	-	2,732
	STRU-4X-3660-RT	36 x 60	2,111	3,536	-	2,321
	STRU-4X-3666-RT	36 x 66	2,204	3,718	-	2,425
	STRU-4X-3672-RT	36 x 72	2,417	4,096	-	2,658
	STRU-4X-3684-RT	36 x 84	2,532	4,429	-	2,786
	STRU-4X-3696-RT	36 x 96	2,725	4,918	-	2,997
	STRU-4X-36108-RT	36 x 108	3,201	6,384	-	-
	STRU-4X-36120-RT	36 x 120	3,525	7,049	-	-
	STRU-4X-4272-RT	42 x 72	2,483	4,320	-	-
	STRU-4X-4284-RT	42 x 84	2,896	4,960	-	-
	STRU-4X-4296-RT	42 x 96	3,077	5,473	-	-
	STRU-4X-42108-RT	42 x 108	3,493	6,874	-	-
	STRU-4X-42120-RT	42 x 120	3,673	7,444	-	-
	STRU-4X-4884-RT	48 x 84	2,996	5,421	-	-
	STRU-4X-4896-RT	48 x 96	3,156	5,959	-	-
STRU-4X-48108-RT	48 x 108	3,756	7,594	-	-	
STRU-4X-48120-RT	48 x 120	4,036	8,313	-	-	
Race-track	STRU-4X-2460-RC	24 x 60	1,815	-	-	-
	STRU-4X-2466-RC	24 x 66	1,879	-	-	-
	STRU-4X-2472-RC	24 x 72	2,027	-	-	-
	STRU-4X-2484-RC	24 x 84	2,292	-	-	-
	STRU-4X-2496-RC	24 x 96	2,452	-	-	-
	STRU-4X-3060-RC	30 x 60	2,010	-	-	-
	STRU-4X-3066-RC	30 x 66	2,048	-	-	-
	STRU-4X-3072-RC	30 x 72	2,139	-	-	-

CONFERENCE TABLES

**Structure 4X**

CONFIGURE & PRICE

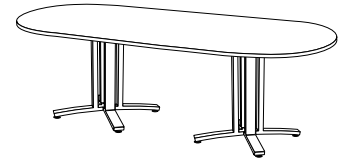

	MODEL NUMBER	SIZE	HPL	WOOD VENEER	1-DAY	5-DAY
Racetrack	STRU-4X-3084-RC	30 x 84	2,632	-	-	-
	STRU-4X-3096-RC	30 x 96	2,763	-	-	-
	STRU-4X-3660-RC	36 x 60	2,301	-	-	-
	STRU-4X-3666-RC	36 x 66	2,502	-	-	-
	STRU-4X-3672-RC	36 x 72	2,543	4,017	-	-
	STRU-4X-3684-RC	36 x 84	2,906	4,536	-	-
	STRU-4X-3696-RC	36 x 96	3,035	4,971	-	-
	STRU-4X-36108-RC	36 x 108	3,575	6,438	-	-
	STRU-4X-36120-RC	36 x 120	3,898	7,565	-	-
	STRU-4X-4272-RC	42 x 72	2,765	-	-	-
	STRU-4X-4284-RC	42 x 84	3,258	5,073	-	-
	STRU-4X-4296-RC	42 x 96	3,492	5,648	-	-
	STRU-4X-42108-RC	42 x 108	3,947	7,033	-	-
	STRU-4X-42120-RC	42 x 120	4,171	7,654	-	-
	STRU-4X-4884-RC	48 x 84	3,390	5,571	-	-
	STRU-4X-4896-RC	48 x 96	3,582	6,155	-	-
STRU-4X-48108-RC	48 x 108	4,261	7,811	-	-	
STRU-4X-48120-RC	48 x 120	4,624	8,623	-	-	
Boat Shape	STRU-4X-2460-BT	24 x 60	1,866	-	-	-
	STRU-4X-2466-BT	24 x 66	1,928	-	-	-
	STRU-4X-2472-BT	24 x 72	2,078	-	-	-
	STRU-4X-2484-BT	24 x 84	2,372	-	-	-
	STRU-4X-2496-BT	24 x 96	2,543	-	-	-
	STRU-4X-3060-BT	30 x 60	2,067	-	-	-
	STRU-4X-3066-BT	30 x 66	2,120	-	-	-
	STRU-4X-3072-BT	30 x 72	2,301	-	-	-
	STRU-4X-3084-BT	30 x 84	2,735	-	-	-
	STRU-4X-3096-BT	30 x 96	2,875	-	-	-
	STRU-4X-3660-BT	36 x 60	2,380	-	-	-
	STRU-4X-3666-BT	36 x 66	2,502	-	-	-
	STRU-4X-3672-BT	36 x 72	2,591	4,216	-	-
	STRU-4X-3684-BT	36 x 84	2,955	4,734	-	-
STRU-4X-3696-BT	36 x 96	3,098	5,185	-	-	



CONFERENCE TABLES

**Structure 4X**

**CONFIGURE & PRICE**



	MODEL NUMBER	SIZE	HPL	WOOD VENEER	1-DAY	5-DAY
Boat Shape	STRU-4X-36108-BT	36 x 108	3,645	6,659	-	-
	STRU-4X-36120-BT	36 x 120	3,988	7,356	-	-
	STRU-4X-4272-BT	42 x 72	2,804	-	-	-
	STRU-4X-4284-BT	42 x 84	3,331	5,249	-	-
	STRU-4X-4296-BT	42 x 96	3,572	5,829	-	-
	STRU-4X-42108-BT	42 x 108	4,028	7,203	-	-
	STRU-4X-42120-BT	42 x 120	4,261	7,831	-	-
	STRU-4X-4884-BT	48 x 84	3,462	5,789	-	-
	STRU-4X-4896-BT	48 x 96	3,671	6,391	-	-
	STRU-4X-48108-BT	48 x 108	4,360	8,056	-	-
STRU-4X-48120-BT	48 x 120	4,746	8,891	-	-	

**Structure 4X Options**

DESCRIPTION	ADD-ON
2 Piece Tabletop Standard for sizes over 108"	-
1 Piece Tabletop for sizes up to 168"	586

**Accessories for Conference Tables**

OPTION	DESCRIPTION	PRICE
Grommet	Round or Rectangle	Visit SpecialT.net
Power & Data Management	Burele, EZ Power, Interact G2, Cove, Oasis, Stafford, Villa, Qi Wireless Charger	
Wire Management	Loop Clips, Velcro Loop, Cable Grip, J-shape Wire Channel, Snap Wire Channel, Wire Trough, Wire Tray, 1" Wire Channel, Magnetic Channel, Adjustable Spine	
Chairs	Task, Stacking, Flipper, Sled	

\*An Oversize Fee has been implemented by freight carriers for all LTL shipments for pallets 8' and over.  
96"-108" - additional 250.00 | 109" -168" - additional 350.00 | Per custom pallet

CONFERENCE TABLES

**Structure Cube**

CONFIGURE & PRICE

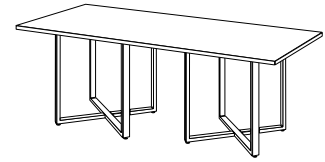

	MODEL NUMBER	SIZE	HPL	WOOD VENEER	1-DAY	5-DAY
Rectangle	STRU-CU-3666-RT	36 x 66	2,198	3,712	-	2,417
	STRU-CU-3672-RT	36 x 72	2,321	4,000	-	2,556
	STRU-CU-3684-RT	36 x 84	2,611	4,508	-	2,871
	STRU-CU-3696-RT	36 x 96	2,720	4,913	-	2,992
	STRU-CU-36108-RT	36 x 108	3,091	6,274	-	-
	STRU-CU-36120-RT	36 x 120	3,391	6,915	-	-
	STRU-CU-4272-RT	42 x 72	2,713	4,550	-	-
	STRU-CU-4284-RT	42 x 84	3,171	5,235	-	-
	STRU-CU-4296-RT	42 x 96	3,381	5,777	-	-
	STRU-CU-42108-RT	42 x 108	3,735	7,116	-	-
	STRU-CU-42120-RT	42 x 120	3,815	7,586	-	-
	STRU-CU-4884-RT	48 x 84	3,480	5,905	-	-
	STRU-CU-4896-RT	48 x 96	3,663	6,466	-	-
	STRU-CU-48108-RT	48 x 108	4,036	7,874	-	-
	STRU-CU-48120-RT	48 x 120	4,329	8,606	-	-
	STRU-CU-6096-RT	60 x 96	3,670	7,086	-	-
	STRU-CU-60108-RT	60 x 108	3,973	8,467	-	-
	STRU-CU-60120-RT	60 x 120	4,265	9,294	-	-
Racetrack	STRU-CU-3666-RC	36 x 66	2,364	-	-	-
	STRU-CU-3672-RC	36 x 72	2,502	3,976	-	-
	STRU-CU-3684-RC	36 x 84	2,865	4,495	-	-
	STRU-CU-3696-RC	36 x 96	2,996	4,932	-	-
	STRU-CU-36108-RC	36 x 108	3,535	6,398	-	-
	STRU-CU-36120-RC	36 x 120	3,937	7,604	-	-
	STRU-CU-4272-RC	42 x 72	2,846	-	-	-
	STRU-CU-4284-RC	42 x 84	3,341	5,156	-	-
	STRU-CU-4296-RC	42 x 96	3,572	5,728	-	-
	STRU-CU-42108-RC	42 x 108	4,028	7,114	-	-
	STRU-CU-42120-RC	42 x 120	4,250	7,733	-	-
	STRU-CU-4884-RC	48 x 84	3,671	5,852	-	-
	STRU-CU-4896-RC	48 x 96	3,863	6,436	-	-
	STRU-CU-48108-RC	48 x 108	4,543	8,093	-	-
STRU-CU-48120-RC	48 x 120	4,906	8,905	-	-	

CONFERENCE TABLES

**Structure Cube**

**CONFIGURE & PRICE**

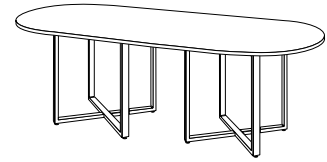

	MODEL NUMBER	SIZE	HPL	WOOD VENEER	1-DAY	5-DAY
Racetrack	STRU-CU-6096-RC	60 x 96	3,790	6,918	-	-
	STRU-CU-60108-RC	60 x 108	4,455	8,606	-	-
	STRU-CU-60120-RC	60 x 120	4,774	9,470	-	-
Boat Shape	STRU-CU-3672-BT	36 x 72	2,551	4,176	-	-
	STRU-CU-3684-BT	36 x 84	2,917	4,696	-	-
	STRU-CU-3696-BT	36 x 96	3,056	5,143	-	-
	STRU-CU-36108-BT	36 x 108	3,614	6,628	-	-
	STRU-CU-36120-BT	36 x 120	4,020	7,388	-	-
	STRU-CU-4272-BT	42 x 72	2,896	-	-	-
	STRU-CU-4284-BT	42 x 84	3,410	5,328	-	-
	STRU-CU-4296-BT	42 x 96	3,652	5,909	-	-
	STRU-CU-42108-BT	42 x 108	4,108	7,283	-	-
	STRU-CU-42120-BT	42 x 120	4,341	7,911	-	-
	STRU-CU-4884-BT	48 x 84	3,744	6,071	-	-
	STRU-CU-4896-BT	48 x 96	3,955	6,675	-	-
	STRU-CU-48108-BT	48 x 108	4,653	8,349	-	-
	STRU-CU-48120-BT	48 x 120	5,027	9,172	-	-
	STRU-CU-6096-BT	60 x 96	3,863	7,137	-	-
	STRU-CU-60108-BT	60 x 108	4,563	8,860	-	-
	STRU-CU-60120-BT	60 x 120	4,930	9,773	-	-
	Round	STRU-CU-42-RD	42"	1,697	2,659	-
STRU-CU-48-RD		48"	1,864	3,195	-	2,050
STRU-CU-54-RD		54"	2,166	3,680	-	2,384
STRU-CU-60-RD		60"	2,319	4,298	-	2,550
STRU-CU-72-RD		72"	3,474	6,182	-	3,821
Square	STRU-CU-4242-SQ	42 x 42	2,609	-	1,675	1,522
	STRU-CU-4848-SQ	48 x 48	3,271	-	1,953	1,775
	STRU-CU-5454-SQ	54 x 54	3,548	-	2,012	1,829
	STRU-CU-6060-SQ	60 x 60	4,164	-	2,140	1,945

CONFERENCE TABLES  
**Structure Cube**

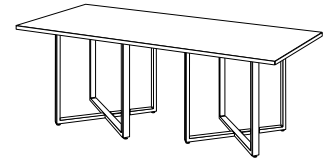

**Structure Cube Options**

DESCRIPTION	ADD-ON
2 Piece Tabletop Standard for sizes over 108"	-
1 Piece Tabletop for sizes up to 168"	586

**Accessories for Conference Tables**

OPTION	DESCRIPTION	PRICE
Grommet	Round or Rectangle	Visit SpecialT.net
Power & Data Management	Burele, EZ Power, Interact G2, Cove, Oasis, Stafford, Villa, Qi Wireless Charger	
Wire Management	Loop Clips, Velcro Loop, Cable Grip, J-shape Wire Channel, Snap Wire Channel, Wire Trough, Wire Tray, 1" Wire Channel, Magnetic Channel, Adjustable Spine	
Chairs	Task, Stacking, Flipper, Sled	

\*An Oversize Fee has been implemented by freight carriers for all LTL shipments for pallets 8' and over.  
 96"-108" - additional 250.00 | 109" -168" - additional 350.00 | Per custom pallet

CONFERENCE TABLES

**Venice**

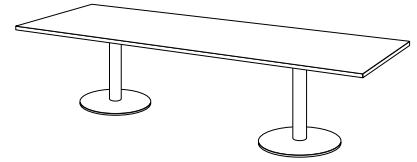

CONFIGURE & PRICE

	MODEL NUMBER	SIZE	HPL	WOOD VENEER	1-DAY	5-DAY
Rectangle	VNCE-3660-RT	36 x 60	2,099	3,524	-	-
	VNCE-3666-RT	36 x 66	2,210	3,724	-	-
	VNCE-3672-RT	36 x 72	2,260	3,939	-	-
	VNCE-3678-RT	36 x 78	2,430	4,200	-	-
	VNCE-3684-RT	36 x 84	2,547	4,444	-	-
	VNCE-3696-RT	36 x 96	2,655	4,848	-	-
	VNCE-36108-RT	36 x 108	3,879	7,062	-	-
	VNCE-36120-RT	36 x 120	4,142	7,666	-	-
	VNCE-36144-RT	36 x 144	6,786	10,838	-	-
	VNCE-4278-RT	42 x 78	2,085	4,010	-	-
	VNCE-4284-RT	42 x 84	2,372	4,436	-	-
	VNCE-4296-RT	42 x 96	2,563	4,959	-	-
	VNCE-42108-RT	42 x 102	3,087	6,468	-	-
	VNCE-42120-RT	42 x 120	3,314	7,085	-	-
VNCE-42144-RT	42 x 144	5,705	10,050	-	-	
Racetrack	VNCE-3660-RC	36 x 60	2,379	-	-	-
	VNCE-3666-RC	36 x 66	2,494	-	-	-
	VNCE-3672-RC	36 x 72	2,545	4,019	-	-
	VNCE-3678-RC	36 x 78	2,759	4,257	-	-
	VNCE-3684-RC	36 x 84	2,904	4,534	-	-
	VNCE-3696-RC	36 x 96	3,128	5,064	-	-
	VNCE-36108-RC	36 x 108	3,693	6,556	-	-
	VNCE-36120-RC	36 x 120	4,105	7,772	-	-
	VNCE-36144-RC	36 x 144	5,122	8,899	-	-
	VNCE-4278-RC	42 x 78	3,777	5,392	-	-
	VNCE-4284-RC	42 x 84	4,135	5,950	-	-
	VNCE-4296-RC	42 x 96	4,376	6,532	-	-
	VNCE-42108-RC	42 x 108	4,846	7,932	-	-
	VNCE-42120-RC	42 x 120	5,684	9,167	-	-
VNCE-42144-RC	42 x 144	6,289	10,383	-	-	

CONFERENCE TABLES

**Venice**

CONFIGURE & PRICE

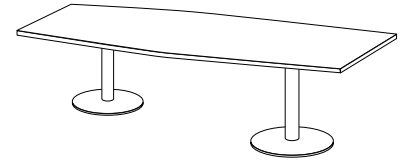

	MODEL NUMBER	SIZE	HPL	WOOD VENEER	1-DAY	5-DAY
Boat Shape	VNCE-3660-BT	36 x 60	2,417	-	-	-
	VNCE-3666-BT	36 x 66	2,539	-	-	-
	VNCE-3672-BT	36 x 72	2,585	4,210	-	-
	VNCE-3684-BT	36 x 84	2,963	4,742	-	-
	VNCE-3696-BT	36 x 96	3,192	5,279	-	-
	VNCE-36108-BT	36 x 108	3,679	6,693	-	-
	VNCE-36120-BT	36 x 120	4,106	7,474	-	-
	VNCE-36144-BT	36 x 144	4,580	8,507	-	-
	VNCE-4278-BT	42 x 78	2,505	4,227	-	-
	VNCE-4284-BT	42 x 84	2,874	4,792	-	-
	VNCE-4296-BT	42 x 96	3,127	5,384	-	-
	VNCE-42108-BT	42 x 108	3,603	6,778	-	-
	VNCE-42120-BT	42 x 120	3,838	7,408	-	-
	VNCE-42144-BT	42 x 144	6,413	10,577	-	-
Oval	VNCE-3660-OV	36 x 60	2,535	-	-	-
	VNCE-3666-OV	36 x 66	2,671	-	-	-
	VNCE-3672-OV	36 x 72	2,813	4,347	-	-
	VNCE-3684-OV	36 x 84	3,146	4,837	-	-
	VNCE-3696-OV	36 x 96	3,390	5,390	-	-
	VNCE-36108-OV	36 x 108	3,909	6,833	-	-
	VNCE-36120-OV	36 x 120	4,386	7,668	-	-
	VNCE-36144-OV	36 x 144	4,911	8,759	-	-
	VNCE-4278-OV	42 x 78	2,682	4,342	-	-
	VNCE-4284-OV	42 x 84	3,101	4,959	-	-
	VNCE-4296-OV	42 x 96	3,380	5,584	-	-
	VNCE-42108-OV	42 x 108	3,879	7,008	-	-
	VNCE-42120-OV	42 x 120	4,142	7,673	-	-
	VNCE-42144-OV	42 x 144	6,786	10,931	-	-

CONFERENCE TABLES

**Venice**

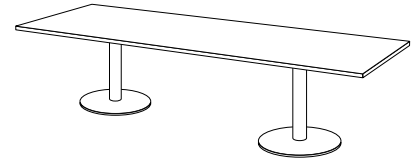

MODEL NUMBER	DESCRIPTION	ADD-ON	
		UP TO 120" LONG	144" LONG
-BH	Bar Height 42"	170	255
		UP TO 96" LONG	108" - 144" LONG
	2 Piece Tabletop Standard for sizes over 108"	-	-
	1 Piece Tabletop for sizes 108" to 168"	-	586

**Accessories for Conference Tables**

OPTION	DESCRIPTION	PRICE
Grommet	Round or Rectangle	Visit SpecialT.net
Power & Data Management	Burele, EZ Power, Interact G2, Cove, Oasis, Stafford, Villa, Qi Wireless Charger	
Wire Management	Loop Clips, Velcro Loop, Cable Grip, J-shape Wire Channel, Snap Wire Channel, Wire Trough, Wire Tray, 1" Wire Channel, Adjustable Spine	
Chairs	Task, Stacking, Flipper, Sled	

\*An Oversize Fee has been implemented by freight carriers for all LTL shipments for pallets 8' and over.  
96"-108" - additional 250.00 | 109" -168" - additional 350.00 | Per custom pallet

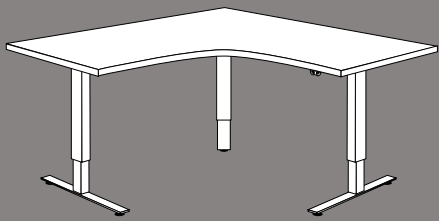

## HEIGHT ADJUSTABLE TABLES



HEIGHT ADJUSTABLE

## Liberty Electric Tables

Rectangle | 2-Legs | Two Stage

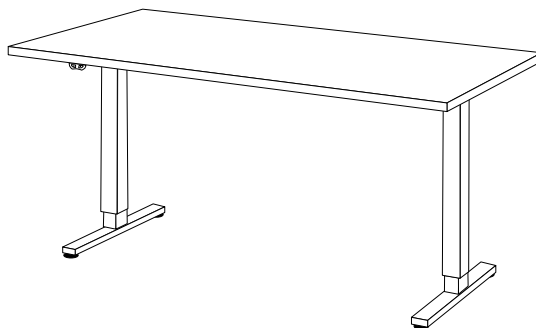

**CONFIGURE & PRICE**

MODEL NUMBER	SIZE	HPL	WOOD VENEER	1-DAY	5-DAY
LIB-2448	24x48	1,647	2,488	1,507	1,812
LIB-2454	24x54	1,712	2,620	-	1,884
LIB-2460	24x60	1,735	2,760	1,575	1,909
LIB-2466	24x66	1,793	2,886	-	1,974
LIB-2472	24x72	1,808	3,020	1,639	1,989
LIB-3048	30x48	1,707	2,813	-	1,878
LIB-3054	30x54	1,786	2,977	-	1,965
LIB-3060	30x60	1,808	3,157	1,654	1,989
LIB-3066	30x66	1,881	3,314	-	2,071
LIB-3072	30x72	1,896	3,486	1,735	2,086

HEIGHT ADJUSTABLE

## Liberty Electric Tables

2-Legs | Two Stage

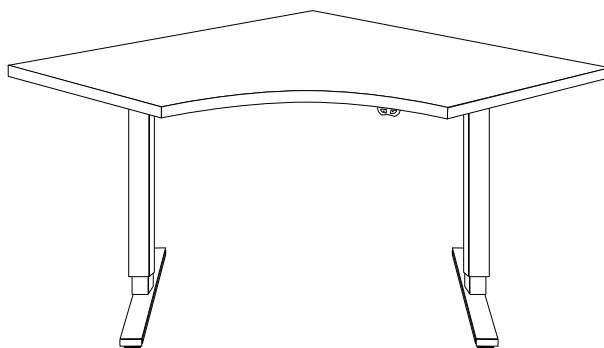

CONFIGURE & PRICE

SHAPE	MODEL NUMBER	SIZE	HPL	WOOD VENEER	1-DAY	5-DAY
Equal Corner	LIB-4224-EC	42 x 42 x 24	2,571	-	-	-
	LIB-4824-EC	48 x 48 x 24	2,626	-	-	-
Trapezoid	LIB-3060-TRA	30 x 60	2,283	3,297	-	-
	LIB-3072-TRA	30 x 72	2,320	3,504	-	-
Half-Round	LIB-3060-HRD	30 x 60	2,116	3,181	-	-
Crescent	LIB-2448-CRE	24 x 48 x 75	2,393	3,525	-	-
	LIB-2460-CRE	24 x 60 x 94	2,576	4,180	-	-
	LIB-3048-CRE	30 x 48 x 75	2,393	3,724	-	-
	LIB-3060-CRE	30 x 60 x 94	2,665	4,432	-	-

HEIGHT ADJUSTABLE

## Liberty Electric Tables

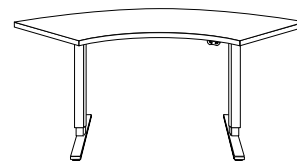

### Liberty Electric Options

ITEM	DESCRIPTION	ADD-ON
Handset	Standard Up/Down Switch (by default)	0
	Digital Display with Memory Preset	110
Base Option	2S - 2 Stage: 27" - 46" height range (by default)	0

### Accessories for Height Adjustable Tables

OPTION	DESCRIPTION	PRICE
Modesty Panels	PET, Perforated Steel, Frosted Acrylic	Visit SpecialT.net
Privacy Screens	PET, Frosted Acrylic, Clear Plexiglass	
Grommet	Round or Rectangle	
Power & Data Management	Burele, EZ Power, Ashley Duo Air, Cove, Dean, Nacre, Node, Mho B, Villa, Qi Wireless Charger	
Wire Management	Loop Clips, Velcro Loop, Cable Grip, J-shape Wire Channel, Snap Wire Channel, Wire Trough, Wire Tray, 1" Wire Channel, Magnetic Channel, Adjustable Spine	
Chairs	Task, Stacking, Flipper, Sled	
Monitor Arms	Single, Dual, Single Arm with Cross Bar	

HEIGHT ADJUSTABLE

## Patriot Electric Tables

Rectangle | 2-Legs | Two Stage

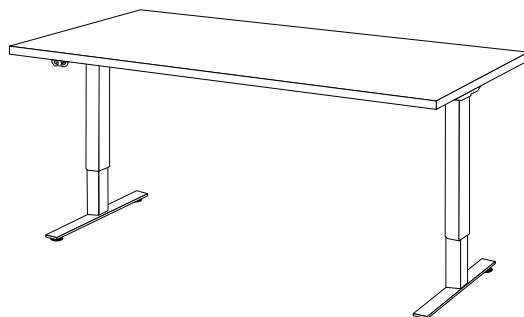

**CONFIGURE & PRICE**

MODEL NUMBER	SIZE	HPL	WOOD VENEER	1-DAY	5-DAY
PATR-2448	24x48	2,184	3,025	1,891	2,403
PATR-2454	24x54	2,264	3,172	-	2,491
PATR-2460	24x60	2,293	3,318	2,000	2,523
PATR-2466	24x66	2,321	3,414	-	2,556
PATR-2472	24x72	2,337	3,549	2,043	2,571
PATR-2478	24x78	2,469	3,748	-	2,716
PATR-2484	24x84	2,590	3,961	-	2,849
PATR-3048	30x48	2,257	3,363	-	2,483
PATR-3054	30x54	2,330	3,521	-	2,563
PATR-3060	30x60	2,351	3,700	2,096	2,587
PATR-3066	30x66	2,396	3,829	-	2,635
PATR-3072	30x72	2,425	4,015	2,132	2,668
PATR-3078	30x78	2,681	4,359	-	2,950
PATR-3084	30x84	2,827	4,670	-	3,111

HEIGHT ADJUSTABLE

## Patriot Electric Tables

Equal Corner | 2-Legs | Two Stage



CONFIGURE & PRICE

MODEL NUMBER	SIZE	HPL	WOOD VENEER	1-DAY	5-DAY
PATR-4224-EC	42 x 42 x 24	2,571	-	-	-
PATR-4824-EC	48 x 48 x 24	2,626	-	-	-
PATR-4830-EC	48 x 48 x 30	2,420	-	-	-

Equal Corner | 3-Legs | Two Stage

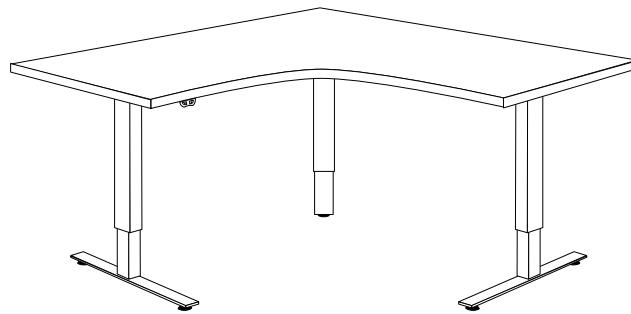

CONFIGURE & PRICE

MODEL NUMBER	SIZE	HPL	WOOD VENEER	1-DAY	5-DAY
PATR-6024-EC	60 x 60 x 24	3,814	-	-	-
PATR-6030-EC	60 x 60 x 30	3,997	-	-	-
PATR-6624-EC	66 x 66 x 24	4,107	-	-	-
PATR-6630-EC	66 x 66 x 30	4,267	-	-	-
PATR-7224-EC	72 x 72 x 24	4,304	-	-	-
PATR-7230-EC	72 x 72 x 30	4,399	-	-	-

HEIGHT ADJUSTABLE

## Patriot Electric Tables

Extended Corner Right | 3-Legs | Two Stage

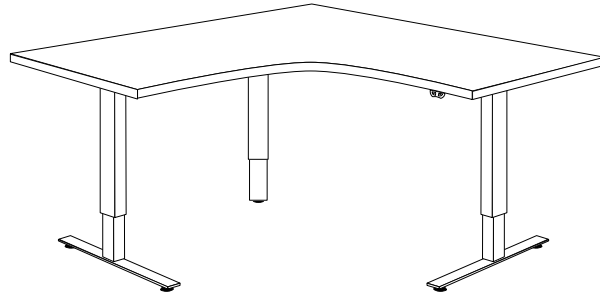

CONFIGURE & PRICE

MODEL NUMBER	SIZE	HPL	WOOD VENEER	1-DAY	5-DAY
PATR-603624-ECR	60 x 36 x 24	3,494	4,773	-	-
PATR-604224-ECR	60 x 42 x 24	3,529	5,011	-	-
PATR-723624-ECR	72 x 36 x 24	3,567	5,025	-	-
PATR-724224-ECR	72 x 42 x 24	3,749	5,495	-	-
PATR-603630-ECR	60 x 36 x 30	3,494	-	-	-
PATR-604230-ECR	60 x 42 x 30	3,529	5,035	-	-
PATR-723630-ECR	72 x 36 x 30	3,567	-	-	-
PATR-724230-ECR	72 x 42 x 30	3,749	5,524	-	-
PATR-604824-ECR	60 x 48 x 24	3,850	5,536	-	-
PATR-724824-ECR	72 x 48 x 24	4,216	6,146	-	-
PATR-726024-ECR	72 x 60 x 24	4,508	6,977	-	-
PATR-843624-ECR	84 x 36 x 24	4,546	-	-	-
PATR-844224-ECR	84 x 42 x 24	4,766	-	-	-
PATR-844824-ECR	84 x 48 x 24	4,801	7,043	-	-
PATR-846024-ECR	84 x 60 x 24	4,986	7,752	-	-
PATR-604830-ECR	60 x 48 x 30	3,850	5,562	-	-
PATR-724830-ECR	72 x 48 x 30	4,216	6,180	-	-
PATR-726030-ECR	72 x 60 x 30	4,508	7,016	-	-
PATR-843630-ECR	84 x 36 x 30	4,546	-	-	-
PATR-844230-ECR	84 x 42 x 30	4,766	-	-	-
PATR-844830-ECR	84 x 48 x 30	4,801	-	-	-
PATR-846030-ECR	84 x 60 x 30	4,986	7,752	-	-

HEIGHT ADJUSTABLE

## Patriot Electric Tables

Extended Corner Right | 3-Legs | Two Stage

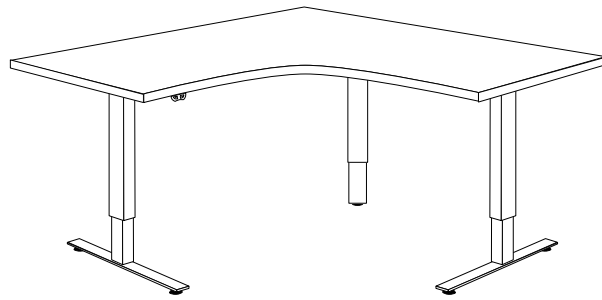

**CONFIGURE & PRICE**

MODEL NUMBER	SIZE	HPL	WOOD VENEER	1-DAY	5-DAY
PATR-603624-ECL	60 x 36 x 24	3,494	4,773	-	-
PATR-604224-ECL	60 x 42 x 24	3,529	5,011	-	-
PATR-723624-ECL	72 x 36 x 24	3,567	5,025	-	-
PATR-724224-ECL	72 x 42 x 24	3,749	5,495	-	-
PATR-603630-ECL	60 x 36 x 30	3,494	-	-	-
PATR-604230-ECL	60 x 42 x 30	3,529	5,035	-	-
PATR-723630-ECL	72 x 36 x 30	3,567	-	-	-
PATR-724230-ECL	72 x 42 x 30	3,749	5,524	-	-
PATR-604824-ECL	60 x 48 x 24	3,850	5,536	-	-
PATR-724824-ECL	72 x 48 x 24	4,216	6,146	-	-
PATR-726024-ECL	72 x 60 x 24	4,508	6,977	-	-
PATR-843624-ECL	84 x 36 x 24	4,546	-	-	-
PATR-844224-ECL	84 x 42 x 24	4,766	-	-	-
PATR-844824-ECL	84 x 48 x 24	4,801	7,043	-	-
PATR-846024-ECL	84 x 60 x 24	4,986	7,752	-	-
PATR-604830-ECL	60 x 48 x 30	3,850	5,562	-	-
PATR-724830-ECL	72 x 48 x 30	4,216	6,180	-	-
PATR-726030-ECL	72 x 60 x 30	4,508	7,016	-	-
PATR-843630-ECL	84 x 36 x 30	4,546	-	-	-
PATR-844230-ECL	84 x 42 x 30	4,766	-	-	-
PATR-844830-ECL	84 x 48 x 30	4,801	-	-	-
PATR-846030-ECL	84 x 60 x 30	4,986	7,752	-	-

HEIGHT ADJUSTABLE

## Patriot Electric Tables Options

ITEM	DESCRIPTION	ADD-ON	
		2-LEGS	3-LEGS
Base Option	2S - 2 Stage: 27" - 46" height range (by default)	-	
	3S - 3 Stage: 23" - 48" height range	138	153
Handset	Standard Up/Down Switch (by default)	-	
	Digital Display with Memory Preset	110	
PAT-C	Casters	146	

### Accessories for Height Adjustable Tables

OPTION	DESCRIPTION	PRICE
Modesty Panels	PET, Perforated Steel, Frosted Acrylic	Visit <a href="http://SpecialT.net">SpecialT.net</a>
Privacy Screens	PET, Frosted Acrylic, Clear Plexiglass	
Grommets	Round or Rectangle	
Power & Data Management	Burele, EZ Power, Ashley Duo Air, Cove, Dean, Nacre, Node, Mho B, Villa, Qi Wireless Charger	
Wire Management	Loop Clips, Velcro Loop, Cable Grip, J-shape Wire Channel, Snap Wire Channel, Wire Trough, Wire Tray, 1" Wire Channel, Magnetic Channel, Adjustable Spine	
Chairs	Task, Stacking, Flipper, Sled	
Monitor Arms	Single, Dual, Single Arm with Cross Bar	



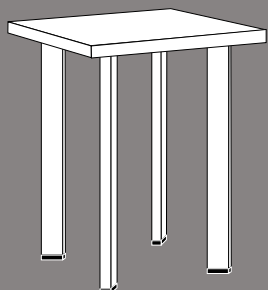

## OCCASIONAL TABLES



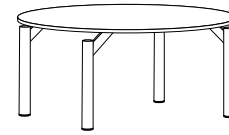

OCCASIONAL TABLES

**Relax Series | RLX1**



**Coffee Table - 17" High**

**CONFIGURE & PRICE**

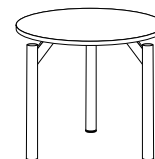

SHAPE	MODEL NUMBER	SIZE	3MM EDGE	KNIFE EDGE
<b>Round</b> 	RLX1-30R-17	30"	1,243	1,491
	RLX1-36R-17	36"	1,369	1,642
	RLX1-42R-17	42"	1,594	1,913
	RLX1-48R-17	48"	1,647	1,976
<b>Square</b> 	RLX1-3030-17	30 x 30	1,207	1,449
	RLX1-3636-17	36 x 36	1,333	1,601
	RLX1-4242-17	42 x 42	1,559	1,871
	RLX1-4848-17	48 x 48	1,611	1,933
<b>Rectangle</b> 	RLX1-1830-17	18 x 30	908	1,090
	RLX1-1836-17	18 x 36	937	1,124
	RLX1-1842-17	18 x 42	995	1,195
	RLX1-2030-17	20 x 30	915	1,098
	RLX1-2036-17	20 x 36	951	1,141
	RLX1-2042-17	20 x 42	1,003	1,204
	RLX1-2436-17	24 x 36	981	1,177
	RLX1-2442-17	24 x 42	1,061	1,274
	RLX1-2448-17	24 x 48	1,069	1,283
<b>Oval</b> 	RLX1-2030-OV-17	20 x 30	1,243	1,491
	RLX1-2036-OV-17	20 x 36	1,273	1,529
	RLX1-2042-OV-17	20 x 42	1,302	1,562
	RLX1-2048-OV-17	20 x 48	1,333	1,601
	RLX1-2436-OV-17	24 x 36	1,311	1,572
	RLX1-2442-OV-17	24 x 42	1,339	1,608
	RLX1-2448-OV-17	24 x 48	1,369	1,642
	RLX1-3042-OV-17	30 x 42	1,399	1,680
	RLX1-3048-OV-17	30 x 48	1,428	1,713

OCCASIONAL TABLES  
**Relax Series | RLX1**



**End Table - 22" High**

**CONFIGURE & PRICE**

SHAPE	MODEL NUMBER	SIZE	3MM EDGE LIST PRICE	KNIFE EDGE LIST PRICE
<b>Round</b> 	RLX1-16R-22	16"	937	1,124
	RLX1-18R-22	18"	965	1,159
	RLX1-20R-22	20"	995	1,195
	RLX1-24R-22	24"	1,025	1,229
<b>Square</b> 	RLX1-1616-22	16 x 16	900	1,080
	RLX1-1818-22	18 x 18	929	1,115
	RLX1-2020-22	20 x 20	960	1,152
	RLX1-2424-22	24 x 24	988	1,185
<b>Rounded Triangle</b> 	RLX1-18RTRI-22	18 x 18	995	1,195
	RLX1-20RTRI-22	20 x 20	1,025	1,229
	RLX1-24RTRI-22	24 x 24	1,054	1,265

**RLX-1 Options**

MODEL NO.	DESCRIPTION	Coffee Table - 17" Height Add On		End Table - 22" Height Add On	
-CA-RLX	Caster	Round, Square, Rectangle, Oval Tables	76	Square Table	76
				Round, Rounded Triangle Tables	57

**Accessories for Occasional Tables**

Power Management	Burele, Node, Nacre (2 Power only), Qi Wireless Charger	Visit SpecialT.net
Horizontal Wire Management	Loop Clips, Velcro Loop	



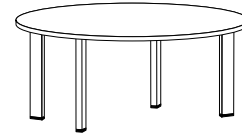

OCCASIONAL TABLES

**Relax Series | RLX2**



**Coffee Table - 17" High**

**CONFIGURE & PRICE**

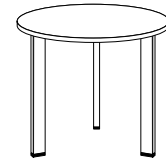

SHAPE	MODEL NUMBER	SIZE	3MM EDGE	KNIFE EDGE
<b>Round</b> 	RLX2-30R-17	30"	1,207	1,455
	RLX2-36R-17	36"	1,333	1,606
	RLX2-42R-17	42"	1,559	1,878
	RLX2-48R-17	48"	1,611	1,940
<b>Square</b> 	RLX2-3030-17	30 x 30	1,171	1,413
	RLX2-3636-17	36 x 36	1,296	1,564
	RLX2-4242-17	42 x 42	1,522	1,834
	RLX2-4848-17	48 x 48	1,575	1,897
<b>Rectangle</b> 	RLX2-1830-17	18 x 30	886	1,068
	RLX2-1836-17	18 x 36	915	1,102
	RLX2-1842-17	18 x 42	981	1,181
	RLX2-2030-17	20 x 30	893	1,076
	RLX2-2036-17	20 x 36	937	1,127
	RLX2-2042-17	20 x 42	988	1,189
	RLX2-2436-17	24 x 36	960	1,156
	RLX2-2442-17	24 x 42	1,032	1,245
	RLX2-2448-17	24 x 48	1,047	1,261
<b>Oval</b> 	RLX2-2030-OV-17	20 x 30	1,207	1,455
	RLX2-2036-OV-17	20 x 36	1,238	1,494
	RLX2-2042-OV-17	20 x 42	1,267	1,527
	RLX2-2048-OV-17	20 x 48	1,296	1,564
	RLX2-2436-OV-17	24 x 36	1,273	1,534
	RLX2-2442-OV-17	24 x 42	1,302	1,571
	RLX2-2448-OV-17	24 x 48	1,333	1,606
	RLX2-3042-OV-17	30 x 42	1,361	1,642
	RLX2-3048-OV-17	30 x 48	1,390	1,675

OCCASIONAL TABLES  
**Relax Series | RLX2**



**End Table - 22" High**

**CONFIGURE & PRICE**

SHAPE	MODEL NUMBER	SIZE	3MM EDGE LIST PRICE	KNIFE EDGE LIST PRICE
<b>Round</b> 	RLX2-16R-22	16"	900	1,087
	RLX2-18R-22	18"	929	1,123
	RLX2-20R-22	20"	960	1,160
	RLX2-24R-22	24"	988	1,192
<b>Square</b> 	RLX2-1616-22	16 x 16	863	1,043
	RLX2-1818-22	18 x 18	893	1,079
	RLX2-2020-22	20 x 20	922	1,114
	RLX2-2424-22	24 x 24	951	1,148
<b>Rounded Triangle</b> 	RLX2-18RTRI-22	18 x 18	965	1,165
	RLX2-20RTRI-22	20 x 20	995	1,199
	RLX2-24RTRI-22	24 x 24	1,025	1,236

**Accessories for Occasional Tables**

Power Management	Burele, Node, Nacre (2 Power only), Qi Wireless Charger	Visit SpecialT.net
Horizontal Wire Management	Loop Clips, Velcro Loop	



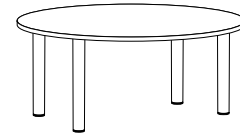

OCCASIONAL TABLES

**Relax Series | RLX3**



**Coffee Table - 17" High**

**CONFIGURE & PRICE**

SHAPE	MODEL NUMBER	SIZE	3MM EDGE	KNIFE EDGE
<b>Round</b> 	RLX3-30R-17	30"	988	1,236
	RLX3-36R-17	36"	1,083	1,356
	RLX3-42R-17	42"	1,193	1,512
	RLX3-48R-17	48"	1,317	1,646
<b>Square</b> 	RLX3-3030-17	30 x 30	951	1,193
	RLX3-3636-17	36 x 36	1,047	1,315
	RLX3-4242-17	42 x 42	1,155	1,467
	RLX3-4848-17	48 x 48	1,281	1,603
<b>Rectangle</b> 	RLX3-1830-17	18 x 30	761	943
	RLX3-1836-17	18 x 36	790	977
	RLX3-1842-17	18 x 42	819	1,019
	RLX3-2030-17	20 x 30	768	951
	RLX3-2036-17	20 x 36	799	989
	RLX3-2042-17	20 x 42	828	1,029
	RLX3-2436-17	24 x 36	893	1,089
	RLX3-2442-17	24 x 42	922	1,135
	RLX3-2448-17	24 x 48	951	1,165
<b>Oval</b> 	RLX3-2030-OV-17	20 x 30	1,097	1,345
	RLX3-2036-OV-17	20 x 36	1,127	1,383
	RLX3-2042-OV-17	20 x 42	1,155	1,415
	RLX3-2048-OV-17	20 x 48	1,186	1,454
	RLX3-2436-OV-17	24 x 36	1,164	1,425
	RLX3-2442-OV-17	24 x 42	1,193	1,462
	RLX3-2448-OV-17	24 x 48	1,223	1,496
	RLX3-3042-OV-17	30 x 42	1,252	1,533
	RLX3-3048-OV-17	30 x 48	1,281	1,566

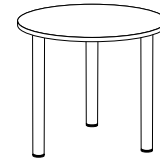

OCCASIONAL TABLES

**Relax Series | RLX3**



**End Table - 22" High**

**CONFIGURE & PRICE**

SHAPE	MODEL NUMBER	SIZE	3MM EDGE LIST PRICE	KNIFE EDGE LIST PRICE
<b>Round</b> 	RLX3-16R-22	16"	790	977
	RLX3-18R-22	18"	819	1,013
	RLX3-20R-22	20"	849	1,049
	RLX3-24R-22	24"	878	1,082
<b>Square</b> 	RLX3-1616-22	16 x 16	754	934
	RLX3-1818-22	18 x 18	783	969
	RLX3-2020-22	20 x 20	813	1,005
	RLX3-2424-22	24 x 24	842	1,039
<b>Rounded Triangle</b> 	RLX3-18RTRI-22	18 x 18	805	1,005
	RLX3-20RTRI-22	20 x 20	833	1,037
	RLX3-24RTRI-22	24 x 24	863	1,074

**RLX-3 Options**

MODEL NO.	DESCRIPTION	Coffee Table - 17" Height Add On		End Table - 22" Height Add On	
-CA-RLX	Caster	Round, Square, Rectangle, Oval Tables	76	Square Table	76
				Round, Rounded Triangle Tables	57

**Accessories for Occasional Tables**

Power Management	Burele, Node, Nacre (2 Power only), Qi Wireless Charger	Visit SpecialT.net
Horizontal Wire Management	Loop Clips, Velcro Loop	



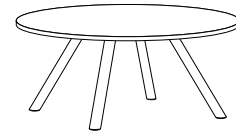

OCCASIONAL TABLES

**Relax Series | RLX4**



**Coffee Table - 17" High**

**CONFIGURE & PRICE**

SHAPE	MODEL NUMBER	SIZE	3MM EDGE	KNIFE EDGE
<b>Round</b> 	RLX4-30R-17	30"	1,025	1,273
	RLX4-36R-17	36"	1,120	1,393
	RLX4-42R-17	42"	1,229	1,548
	RLX4-48R-17	48"	1,353	1,682
<b>Square</b> 	RLX4-3030-17	30 x 30	988	1,230
	RLX4-3636-17	36 x 36	1,083	1,351
	RLX4-4242-17	42 x 42	1,193	1,505
	RLX4-4848-17	48 x 48	1,317	1,639
<b>Rectangle</b> 	RLX4-1830-17	18 x 30	799	981
	RLX4-1836-17	18 x 36	828	1,015
	RLX4-1842-17	18 x 42	856	1,056
	RLX4-2030-17	20 x 30	805	988
	RLX4-2036-17	20 x 36	833	1,023
	RLX4-2042-17	20 x 42	863	1,064
	RLX4-2436-17	24 x 36	929	1,125
	RLX4-2442-17	24 x 42	960	1,173
	RLX4-2448-17	24 x 48	988	1,202
<b>Oval</b> 	RLX4-2030-OV-17	20 x 30	1,135	1,383
	RLX4-2036-OV-17	20 x 36	1,164	1,420
	RLX4-2042-OV-17	20 x 42	1,193	1,453
	RLX4-2048-OV-17	20 x 48	1,223	1,491
	RLX4-2436-OV-17	24 x 36	1,201	1,462
	RLX4-2442-OV-17	24 x 42	1,229	1,498
	RLX4-2448-OV-17	24 x 48	1,259	1,532
	RLX4-3042-OV-17	30 x 42	1,287	1,568
	RLX4-3048-OV-17	30 x 48	1,317	1,602



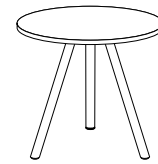

OCCASIONAL TABLES

**Relax Series | RLX4**



**End Table - 22" High**

**CONFIGURE & PRICE**

SHAPE	MODEL NUMBER	SIZE	3MM EDGE LIST PRICE	KNIFE EDGE LIST PRICE
<b>Round</b> 	RLX4-24R-22	24"	915	1,119
<b>Square</b> 	RLX4-1616-22	16 x 16	790	970
	RLX4-1818-22	18 x 18	819	1,005
	RLX4-2020-22	20 x 20	849	1,041
	RLX4-2424-22	24 x 24	878	1,075
<b>Rounded Triangle</b> 	RLX4-24RTRI-22	24 x 24	900	1,111

**RLX-4 Options**

MODEL NO.	DESCRIPTION	Coffee Table - 17" Height Add On		End Table - 22" Height Add On	
-CA-RLX	Caster	Round, Square, Rectangle, Oval Tables	76	Square Table	76
				Round, Rounded Triangle Tables	57

**Accessories for Occasional Tables**

Power Management	Burele, Node, Nacre (2 Power only), Qi Wireless Charger	Visit SpecialT.net
Horizontal Wire Management	Loop Clips, Velcro Loop	

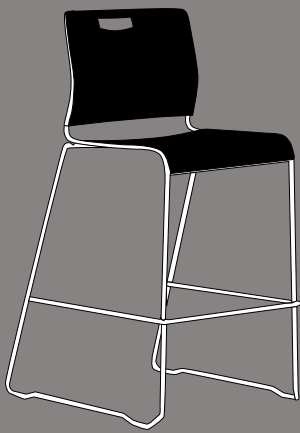





## CHAIRS

ACCESSORIES

**Chairs**



	MODEL NUMBER	DESCRIPTION	BASE PRICE	OPTIONS	DESCRIPTION	ADD-ON			
<b>TASK</b>									
	CH-TASK	Task chair, standard height, black or gray with arms and casters	758	<b>SEAT &amp; BACK COLORS</b>	<b>COLOR</b>  Black Onyx is the stock color. Apple, Aqua, Cloud, Crimson, Dove, Electric Blue, Latte, Lemon, Tangerine, extended time applies	0			
<b>STACK</b>									
	CH-STACK	Stacking chair, standard height, black/silver, with arms	565						
<b>FLIPPER</b>									
	CH-FLIP	Flipper Chair, standard height, black/silver, with arms, with casters	673						
<b>SLED</b>									
<b>SLED STANDARD HEIGHT</b>									
	CH-SLED	Sled chair, standard height black/silver, no glides	303	<b>SLED CHAIRS</b>	CH-GLIDE-PL CH-GLIDE-FELT	27 42			
<b>SLED BAR HEIGHT</b>									
	CH-SLED-BH	Sled chair, bar height black/silver, no glides	555	SEAT BACK COLOR	Black Swan is the stock color, Crimson Red, Federal Blue, Dove Gray, Cloud, Lagoon, Latte, Azure Blue, Tangerine Orange, Apple Green, Lemon Yellow, White Whisper, extended lead time applies	0			

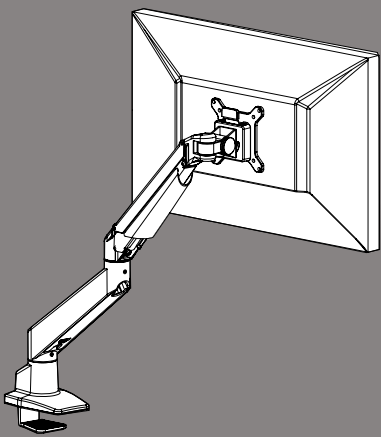



## ADJUSTABLE MONITOR ARMS

ACCESSORIES

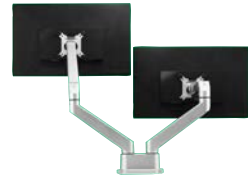
# Adjustable Monitor Arms

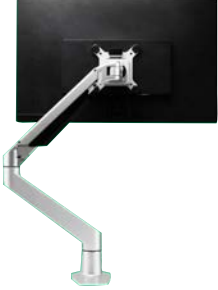
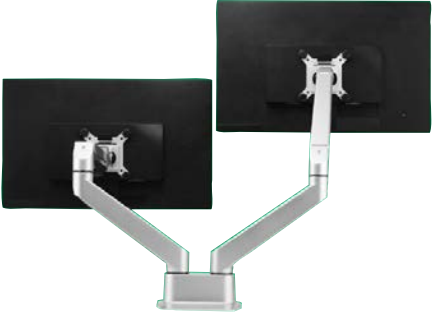



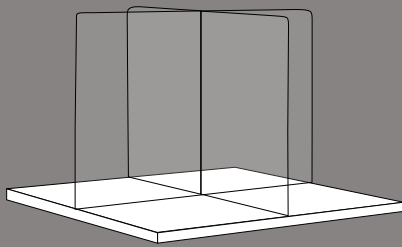



	MODEL NUMBER	DESCRIPTION	BASE PRICE
<b>SINGLE FOR ONE MONITOR</b>			
	MA-S1-A1	Adjustable monitor arm, single, metallic silver	402
<b>DUAL FOR TWO MONITORS</b>			
	MA-S1-A2	Adjustable monitor arm, dual, metallic silver	708
<b>SINGLE WITH CROSS BAR FOR TWO MONITORS</b>			
	MA-S1-X2	Adjustable monitor arm, cross bar with MA-S1-A1, metallic silver	574



# SAFE-T SCREENS & BARRIERS

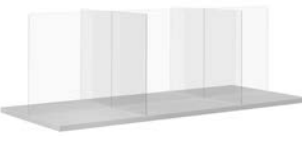

## Clear Plexiglass X-Shape Screens Side to Side Placement

[CONFIGURE & PRICE](#)

X-SHAPE SCREEN SIDE TO SIDE PLACEMENT	MODEL NUMBER	DESCRIPTION	DIMENSIONS H X L X W	LIST PRICE
	PLEX-X243636	X-Shape Safe-T Screens (2) 24"H x 36"L x 0.25"D Clear Plexiglass for 36" Tables, Side to Side Placement	24" x 36" x 36" x 0.25"	336
	PLEX-X244242	X-Shape Safe-T Screens (2) 24"H x 42"L x 0.25"D Clear Plexiglass for 42" Tables, Side to Side Placement	24" x 42" x 42" x 0.25"	381
	PLEX-X244848	X-Shape Safe-T Screens (2) 24"H x 48"L x 0.25"D Clear Plexiglass for 48" Tables, Side to Side Placement	24" x 48" x 48" x 0.25"	442
	PLEX-X246060	X-Shape Safe-T Screens (2) 24"H x 60"L x 0.25"D Clear Plexiglass for 60" Tables, Side to Side Placement	24" x 60" x 60" x 0.25"	623
	PLEX-X242472	X-Shape Safe-T Screens (1) 24"H x 72"L x 0.25"W and (2) 24"H x 23.5"L x 0.25"W Clear Plexiglass for 24" x 72" Tables	24" x 23.5" x 71.5" x 0.25"	676
	PLEX-X243072	X-Shape Safe-T Screens (1) 24"H x 72"L x 0.25"W and (2) 24"H x 29.5"L x 0.25"W Clear Plexiglass for 30" x 72" Tables	24" x 29.5" x 71.5" x 0.25"	730
Other Options	PSCON-24	24"H Vertical Screen Connector		30
	ST-T-2	2" Long Desktop T-Mounts with Double Sided Tape		25

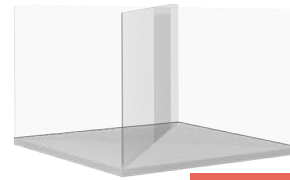
## Clear Plexiglass X-Shape Screens Diagonal Placement

[CONFIGURE & PRICE](#)

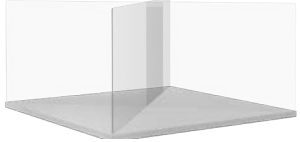
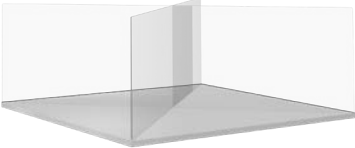
X-SHAPE SCREEN DIAGONAL PLACEMENT	MODEL NUMBER	DESCRIPTION	DIMENSIONS H X L X W	LIST PRICE
	PLEX-X245151-DP	X-Shape Safe-T Screens (2) 24"H x 51"L x 0.25"D Clear Plexiglass for 36" x 36" Square Tables, Diagonal Placement	24" x 51" x 51" x 0.25"	505
	PLEX-X246060-DP	X-Shape Safe-T Screens (2) 24"H x 60"L x 0.25"D Clear Plexiglass for 42" x 42" Square Tables, Diagonal Placement	24" x 60" x 60" x 0.25"	623
	PLEX-X246868-DP	X-Shape Safe-T Screens (2) 24"H x 68"L x 0.25"D Clear Plexiglass for 48" x 48" Square Tables, Diagonal Placement	24" x 68" x 68" x 0.25"	659
	PLEX-X248585-DP	X-Shape Safe-T Screens (2) 24"H x 85"L x 0.25"D Clear Plexiglass for 60" x 60" Square Tables, Diagonal Placement	24" x 85" x 85" x 0.25"	719
Other Options	PSCON-24	24"H Vertical Screen Connector		30
	ST-T-2	2" Long Desktop T-Mounts with Double Sided Tape		25



SAFE-T SCREENS & BARRIERS  
**Clear Plexiglass Screens**



SELF STANDING SCREEN	MODEL NUMBER	DESCRIPTION	DIMENSIONS H X L X W	LIST PRICE
<b>Floor-Standing Safe-T Mobile Divider</b>			<b>CONFIGURE &amp; PRICE</b>	
	ST-RLFRM-3475	Floor-Standing Safe-T Mobile Divider, 34"W x 75"H, Metal frame; Cast Acrylic Screen; Locking Casters; Pre-assembled	34" x 75"	783
	ST-RLFRM-4375	Floor-Standing Safe-T Mobile Divider, 43"W x 75"H, Metal frame; Cast Acrylic Screen; Locking Casters; Pre-assembled	43" x 75"	932
<b>Executive Folding Safe-T Screen</b>			<b>CONFIGURE &amp; PRICE</b>	
	ST-EXE-242412	Executive Folding Safe-T Screen with Metal Hinges; Cast Acrylic; Front Panel 24" x 24"; 2 Side Panels 24" x 12"; Pre-assembled	24" x 48"	464
<b>Safe-T Transaction Screen with Metal Supports</b>			<b>CONFIGURE &amp; PRICE</b>	
	ST-TS-3640	Safe-T Transaction Screen, includes a 36"H X 40"W screen with a 6" X 18" Passthrough Window, and 2 Metal Supports	40" x 36"	719

SAFE-T SCREENS & BARRIERS  
**Clear Plexiglass Screens**



**Worksurface and Cubicle Screens - Permanent Attachment**

**CONFIGURE & PRICE**

HARDWARE	MODEL NUMBER	DESCRIPTION	DIMENSIONS H X L X W	LIST PRICE
	SIDE SCREENS	PLEX1424-PS-BR	14" x 23.5" x 0.25"	162
		PLEX1430-PS-BR	14" x 29.5" x 0.25"	173
	FRONT SCREENS	PLEX1436-PS-BR	14" x 36" x 0.25"	203
		PLEX1442-PS-BR	14" x 42" x 0.25"	227
		PLEX1448-PS-BR	14" x 48" x 0.25"	231
		PLEX1460-PS-BR	14" x 60" x 0.25"	294
		PLEX1472-PS-BR	14" x 72" x 0.25"	329
	SIDE SCREENS	PLEX2424-PS-BR	24" x 23.5" x 0.25"	208
		PLEX2430-PS-BR	24" x 29.5" x 0.25"	237
	FRONT SCREENS	PLEX2436-PS-BR	24" x 36" x 0.25"	275
		PLEX2442-PS-BR	24" x 42" x 0.25"	344
		PLEX2448-PS-BR	24" x 48" x 0.25"	358
		PLEX2460-PS-BR	24" x 60" x 0.25"	415
		PLEX2472-PS-BR	24" x 72" x 0.25"	473
	SIDE SCREENS	PLEX3024-PS-BR	30" x 23.5" x 0.25"	393
		PLEX3030-PS-BR	30" x 29.5" x 0.25"	434
	FRONT SCREENS	PLEX3036-PS-BR	30" x 36" x 0.25"	536
		PLEX3042-PS-BR	30" x 42" x 0.25"	578
		PLEX3048-PS-BR	30" x 48" x 0.25"	620
		PLEX3060-PS-BR	30" x 60" x 0.25"	763
PLEX3072-PS-BR		30" x 72" x 0.25"	845	
Other Options	<b>TOP ALIGNMENT BRACKETS</b>			
	PLEX-BR-AL-S	180° Aluminum Screen Bracket		4
	PLEX-BR-AL-L	90° "L" Aluminum Screen Bracket		6
	PLEX-BR-AL-T	"T" Aluminum Screen Bracket		7
	PLEX-BR-AL-X	"X" Aluminum Screen Bracket		9

Note: Top Alignment Brackets maintain alignment and add stability to Clear Plexiglass, Frosted Acrylic, and Polycarbonate screens. Brackets feature 2-way, 3-way, or 4-way connections and are paired based on project requirements.

SAFE-T SCREENS & BARRIERS  
**Clear Plexiglass Screens**



**Free-Standing or Permanent Attachment Screens**

**CONFIGURE & PRICE**

HARDWARE	MODEL NUMBER	DESCRIPTION	DIMENSIONS H X L X W	LIST PRICE
	SIDE SCREENS	PLEX1424-PS-TMB	14" x 23.5" x 0.25"	188
		PLEX1430-PS-TMB	14" x 29.5" x 0.25"	199
	FRONT SCREENS	PLEX1436-PS-TMB	14" x 36" x 0.25"	229
		PLEX1442-PS-TMB	14" x 42" x 0.25"	253
		PLEX1448-PS-TMB	14" x 48" x 0.25"	257
		PLEX1460-PS-TMB	14" x 60" x 0.25"	333
		PLEX1472-PS-TMB	14" x 72" x 0.25"	368
	SIDE SCREENS	PLEX2424-PS-TMB	24" x 23.5" x 0.25"	234
		PLEX2430-PS-TMB	24" x 29.5" x 0.25"	263
	FRONT SCREENS	PLEX2436-PS-TMB	24" x 36" x 0.25"	301
		PLEX2442-PS-TMB	24" x 42" x 0.25"	383
		PLEX2448-PS-TMB	24" x 48" x 0.25"	397
		PLEX2460-PS-TMB	24" x 60" x 0.25"	454
		PLEX2472-PS-TMB	24" x 72" x 0.25"	512
	SIDE SCREENS	PLEX3024-PS-TMB	30" x 23.5" x 0.25"	419
		PLEX3030-PS-TMB	30" x 29.5" x 0.25"	460
	FRONT SCREENS	PLEX3036-PS-TMB	30" x 36" x 0.25"	575
		PLEX3042-PS-TMB	30" x 42" x 0.25"	617
		PLEX3048-PS-TMB	30" x 48" x 0.25"	659
		PLEX3060-PS-TMB	30" x 60" x 0.25"	815
PLEX3072-PS-TMB		30" x 72" x 0.25"	897	
Other Options	TAPE	Heavy-Duty Double-Sided Tape		18
	<b>TOP ALIGNMENT BRACKETS</b>			
	PLEX-BR-AL-S	180° Aluminum Screen Bracket		4
	PLEX-BR-AL-L	90° "L" Aluminum Screen Bracket		6
	PLEX-BR-AL-T	"T" Aluminum Screen Bracket		7
	PLEX-BR-AL-X	"X" Aluminum Screen Bracket		9

Note: Top Alignment Brackets maintain alignment and add stability to Clear Plexiglass, Frosted Acrylic, and Polycarbonate screens. Brackets feature 2-way, 3-way, or 4-way connections and are paired based on project requirements.

SAFE-T SCREENS & BARRIERS  
**Clear Plexiglass Screens**



**Worksurface Screens with Removable C-Clamp**

**CONFIGURE & PRICE**

HARDWARE	MODEL NUMBER	DESCRIPTION	DIMENSIONS H X L X W	LIST PRICE
	SIDE SCREENS	PLEX1424-PS-C-BR	14" x 23.5" x 0.25"	283
		PLEX1430-PS-C-BR	14" x 29.5" x 0.25"	294
	FRONT SCREENS	PLEX1436-PS-C-BR	14" x 36" x 0.25"	324
		PLEX1442-PS-C-BR	14" x 42" x 0.25"	348
		PLEX1448-PS-C-BR	14" x 48" x 0.25"	352
		PLEX1460-PS-C-BR	14" x 60" x 0.25"	415
		PLEX1472-PS-C-BR	14" x 72" x 0.25"	450
	SIDE SCREENS	PLEX2424-PS-C-BR	24" x 23.5" x 0.25"	329
		PLEX2430-PS-C-BR	24" x 29.5" x 0.25"	358
	FRONT SCREENS	PLEX2436-PS-C-BR	24" x 36" x 0.25"	396
		PLEX2442-PS-C-BR	24" x 42" x 0.25"	465
		PLEX2448-PS-C-BR	24" x 48" x 0.25"	479
		PLEX2460-PS-C-BR	24" x 60" x 0.25"	536
		PLEX2472-PS-C-BR	24" x 72" x 0.25"	594
	SIDE SCREENS	PLEX3024-PS-C-BR	30" x 23.5" x 0.25"	514
		PLEX3030-PS-C-BR	30" x 29.5" x 0.25"	555
	FRONT SCREENS	PLEX3036-PS-C-BR	30" x 36" x 0.25"	657
		PLEX3042-PS-C-BR	30" x 42" x 0.25"	699
		PLEX3048-PS-C-BR	30" x 48" x 0.25"	741
		PLEX3060-PS-C-BR	30" x 60" x 0.25"	884
PLEX3072-PS-C-BR		30" x 72" x 0.25"	966	
Other Options	<b>TOP ALIGNMENT BRACKETS</b>			
	PLEX-BR-AL-S	180° Aluminum Screen Bracket		4
	PLEX-BR-AL-L	90° "L" Aluminum Screen Bracket		6
	PLEX-BR-AL-T	"T" Aluminum Screen Bracket		7
	PLEX-BR-AL-X	"X" Aluminum Screen Bracket		9



Note: Top Alignment Brackets maintain alignment and add stability to Clear Plexiglass, Frosted Acrylic, and Polycarbonate screens. Brackets feature 2-way, 3-way, or 4-way connections and are paired based on project requirements.

SAFE-T SCREENS & BARRIERS  
**Clear Plexiglass Screens**



**Free-Standing Screens for Worksurfaces and Cubicles**

**CONFIGURE & PRICE**

HARDWARE	MODEL NUMBER	DESCRIPTION	DIMENSIONS H X L X W	LIST PRICE	
	SIDE SCREENS	PLEX1424-PS-FOOT	Clear Plexiglass Screen with Free-Standing Foot	14" x 23.5" x 0.25"	283
		PLEX1430-PS-FOOT		14" x 29.5" x 0.25"	294
	FRONT SCREENS	PLEX1436-PS-FOOT		14" x 36" x 0.25"	324
		PLEX1442-PS-FOOT		14" x 42" x 0.25"	348
		PLEX1448-PS-FOOT		14" x 48" x 0.25"	352
		PLEX1460-PS-FOOT		14" x 60" x 0.25"	415
		PLEX1472-PS-FOOT		14" x 72" x 0.25"	450
	SIDE SCREENS	PLEX2424-PS-FOOT		24" x 23.5" x 0.25"	329
		PLEX2430-PS-FOOT		24" x 29.5" x 0.25"	358
	FRONT SCREENS	PLEX2436-PS-FOOT		24" x 36" x 0.25"	396
		PLEX2442-PS-FOOT		24" x 42" x 0.25"	465
		PLEX2448-PS-FOOT		24" x 48" x 0.25"	479
		PLEX2460-PS-FOOT		24" x 60" x 0.25"	536
		PLEX2472-PS-FOOT		24" x 72" x 0.25"	594
	SIDE SCREENS	PLEX3024-PS-FOOT		30" x 23.5" x 0.25"	514
		PLEX3030-PS-FOOT		30" x 29.5" x 0.25"	555
	FRONT SCREENS	PLEX3036-PS-FOOT		30" x 36" x 0.25"	657
		PLEX3042-PS-FOOT		30" x 42" x 0.25"	699
		PLEX3048-PS-FOOT		30" x 48" x 0.25"	741
		PLEX3060-PS-FOOT		30" x 60" x 0.25"	884
PLEX3072-PS-FOOT		30" x 72" x 0.25"	966		
Other Options	MAGNETS	Magnets		91	
	TAPE	Heavy-Duty Double-Sided Tape		18	
	<b>TOP ALIGNMENT BRACKETS</b>				
	PLEX-BR-AL-S	180° Aluminum Screen Bracket		4	
	PLEX-BR-AL-L	90° "L" Aluminum Screen Bracket		6	
	PLEX-BR-AL-T	"T" Aluminum Screen Bracket		7	
	PLEX-BR-AL-X	"X" Aluminum Screen Bracket		9	

Note: Top Alignment Brackets maintain alignment and add stability to Clear Plexiglass, Frosted Acrylic, and Polycarbonate screens. Brackets feature 2-way, 3-way, or 4-way connections and are paired based on project requirements.

Worksurface Screens with Permanent Attachment and Free-Standing Screens can be used to extend cubicle panel height. Use strong magnets, or heavy-duty double-sided tape to avoid cubicle cap damage.

SAFE-T SCREENS & BARRIERS  
**Clear Plexiglass Screens**



**CONFIGURE & PRICE**

**Screens for Cubicle Panels with U-Brackets**

HARDWARE	MODEL NUMBER	DESCRIPTION	DIMENSIONS H X L X W	LIST PRICE
	SIDE SCREENS	PLEX1424-PS-U-BR	14" x 23.5" x 0.25"	374
		PLEX1430-PS-U-BR	14" x 29.5" x 0.25"	385
	FRONT SCREENS	PLEX1436-PS-U-BR	14" x 36" x 0.25"	415
		PLEX1442-PS-U-BR	14" x 42" x 0.25"	439
		PLEX1448-PS-U-BR	14" x 48" x 0.25"	443
		PLEX1460-PS-U-BR	14" x 60" x 0.25"	506
		PLEX1472-PS-U-BR	14" x 72" x 0.25"	541
	SIDE SCREENS	PLEX2424-PS-U-BR	24" x 23.5" x 0.25"	420
		PLEX2430-PS-U-BR	24" x 29.5" x 0.25"	449
	FRONT SCREENS	PLEX2436-PS-U-BR	24" x 36" x 0.25"	487
		PLEX2442-PS-U-BR	24" x 42" x 0.25"	556
		PLEX2448-PS-U-BR	24" x 48" x 0.25"	570
		PLEX2460-PS-U-BR	24" x 60" x 0.25"	627
		PLEX2472-PS-U-BR	24" x 72" x 0.25"	685
	SIDE SCREENS	PLEX3024-PS-U-BR	30" x 23.5" x 0.25"	605
		PLEX3030-PS-U-BR	30" x 29.5" x 0.25"	646
	FRONT SCREENS	PLEX3036-PS-U-BR	30" x 36" x 0.25"	748
		PLEX3042-PS-U-BR	30" x 42" x 0.25"	790
		PLEX3048-PS-U-BR	30" x 48" x 0.25"	832
		PLEX3060-PS-U-BR	30" x 60" x 0.25"	975
PLEX3072-PS-U-BR		30" x 72" x 0.25"	1,057	
Other Options	U-BR-XL	Up-charge for Extra Large U-Brackets for 2.75" - 4.75" Wide Panels		242
	<b>TOP ALIGNMENT BRACKETS</b>			
	PLEX-BR-AL-S	180° Aluminum Screen Bracket		4
	PLEX-BR-AL-L	90° "L" Aluminum Screen Bracket		6
	PLEX-BR-AL-T	"T" Aluminum Screen Bracket		7
	PLEX-BR-AL-X	"X" Aluminum Screen Bracket		9

Note: Top Alignment Brackets maintain alignment and add stability to Clear Plexiglass, Frosted Acrylic, and Polycarbonate screens. Brackets feature 2-way, 3-way, or 4-way connections and are paired based on project requirements.

SAFE-T SCREENS & BARRIERS  
**Frosted Acrylic Screens**



**Worksurface and Cubicle Screens - Permanent Attachment**

**CONFIGURE & PRICE**

HARDWARE	MODEL NUMBER	DESCRIPTION	DIMENSIONS H x L x W	LIST PRICE
	SIDE SCREENS	AP1424-PS-BR	14" x 20.5" x 0.25"	207
		AP1430-PS-BR	14" x 26.5" x 0.25"	207
	FRONT SCREENS	AP1448-PS-BR	14" x 48" x 0.25"	400
		AP1460-PS-BR	14" x 60" x 0.25"	466
		AP1472-PS-BR	14" x 72" x 0.25"	533
	SIDE SCREENS	AP2424-PS-BR	24" x 20.5" x 0.25"	275
		AP2430-PS-BR	24" x 26.5" x 0.25"	337
	FRONT SCREENS	AP2448-PS-BR	24" x 48" x 0.25"	528
		AP2460-PS-BR	24" x 60" x 0.25"	652
		AP2472-PS-BR	24" x 72" x 0.25"	776
	SIDE SCREENS	AP3024-PS-BR	30" x 20.5" x 0.25"	632
		AP3030-PS-BR	30" x 26.5" x 0.25"	747
	FRONT SCREENS	AP3036-PS-BR	30" x 36" x 0.25"	894
		AP3042-PS-BR	30" x 42" x 0.25"	1,010
		AP3048-PS-BR	30" x 48" x 0.25"	1,127
		AP3060-PS-BR	30" x 60" x 0.25"	1,389
AP3072-PS-BR		30" x 72" x 0.25"	1,622	
Other Options		<b>TOP ALIGNMENT BRACKETS</b>		
	PLEX-BR-AL-S	180° Aluminum Screen Bracket		4
	PLEX-BR-AL-L	90° "L" Aluminum Screen Bracket		6
	PLEX-BR-AL-T	"T" Aluminum Screen Bracket		7
	PLEX-BR-AL-X	"X" Aluminum Screen Bracket		9

Note: Top Alignment Brackets maintain alignment and add stability to Clear Plexiglass, Frosted Acrylic, and Polycarbonate screens. Brackets feature 2-way, 3-way, or 4-way connections and are paired based on project requirements.

SAFE-T SCREENS & BARRIERS  
**Frosted Acrylic Screens**



[CONFIGURE & PRICE](#)

**Free-Standing or Permanent Attachment Screens**

HARDWARE	MODEL NUMBER	DESCRIPTION	DIMENSIONS H x L x W	LIST PRICE	
	SIDE SCREENS	AP1424-PS-TMB	14" x 20.5" x 0.25"	233	
		AP1430-PS-TMB	14" x 26.5" x 0.25"	233	
	FRONT SCREENS	AP1448-PS-TMB	Frosted Acrylic Screen with Permanent Attachment or Optional Double-Sided Tape	14" x 48" x 0.25"	426
		AP1460-PS-TMB		14" x 60" x 0.25"	505
		AP1472-PS-TMB		14" x 72" x 0.25"	572
	SIDE SCREENS	AP2424-PS-TMB		24" x 20.5" x 0.25"	301
		AP2430-PS-TMB		24" x 26.5" x 0.25"	363
	FRONT SCREENS	AP2448-PS-TMB		24" x 48" x 0.25"	567
		AP2460-PS-TMB		24" x 60" x 0.25"	691
		AP2472-PS-TMB		24" x 72" x 0.25"	815
	SIDE SCREENS	AP3024-PS-TMB		30" x 20.5" x 0.25"	658
		AP3030-PS-TMB	30" x 26.5" x 0.25"	773	
	FRONT SCREENS	AP3036-PS-TMB	30" x 36" x 0.25"	933	
		AP3042-PS-TMB	30" x 42" x 0.25"	1,049	
		AP3048-PS-TMB	30" x 48" x 0.25"	1,166	
		AP3060-PS-TMB	30" x 60" x 0.25"	1,441	
		AP3072-PS-TMB	30" x 72" x 0.25"	1,674	
	Other Options	TAPE	Heavy-Duty Double-Sided Tape		18
<b>TOP ALIGNMENT BRACKETS</b>					
	PLEX-BR-AL-S	180° Aluminum Screen Bracket		4	
	PLEX-BR-AL-L	90° "L" Aluminum Screen Bracket		6	
	PLEX-BR-AL-T	"T" Aluminum Screen Bracket		7	
	PLEX-BR-AL-X	"X" Aluminum Screen Bracket		9	

Note: Top Alignment Brackets maintain alignment and add stability to Clear Plexiglass, Frosted Acrylic, and Polycarbonate screens. Brackets feature 2-way, 3-way, or 4-way connections and are paired based on project requirements.



SAFE-T SCREENS & BARRIERS  
**Frosted Acrylic Screens**



**Worksurface Screens with Removable C-Clamp**

[CONFIGURE & PRICE](#)

HARDWARE	MODEL NUMBER	DESCRIPTION	DIMENSIONS H x L x W	LIST PRICE
	SIDE SCREENS	AP1424-PS-C-BR	14" x 20.5" x 0.25"	328
		AP1430-PS-C-BR	14" x 26.5" x 0.25"	328
	FRONT SCREENS	AP1448-PS-C-BR	14" x 48" x 0.25"	521
		AP1460-PS-C-BR	14" x 60" x 0.25"	587
		AP1472-PS-C-BR	14" x 72" x 0.25"	654
	SIDE SCREENS	AP2424-PS-C-BR	24" x 20.5" x 0.25"	396
		AP2430-PS-C-BR	24" x 26.5" x 0.25"	458
	FRONT SCREENS	AP2448-PS-C-BR	24" x 48" x 0.25"	649
		AP2460-PS-C-BR	24" x 60" x 0.25"	773
		AP2472-PS-C-BR	24" x 72" x 0.25"	897
	SIDE SCREENS	AP3024-PS-C-BR	30" x 20.5" x 0.25"	753
		AP3030-PS-C-BR	30" x 26.5" x 0.25"	868
	FRONT SCREENS	AP3036-PS-C-BR	30" x 36" x 0.25"	1,015
		AP3042-PS-C-BR	30" x 42" x 0.25"	1,131
		AP3048-PS-C-BR	30" x 48" x 0.25"	1,248
		AP3060-PS-C-BR	30" x 60" x 0.25"	1,510
AP3072-PS-C-BR		30" x 72" x 0.25"	1,743	
		Frosted Acrylic Screen with C-Clamp Attachment		
Other Options	<b>TOP ALIGNMENT BRACKETS</b>			
	PLEX-BR-AL-S	180° Aluminum Screen Bracket		4
	PLEX-BR-AL-L	90° "L" Aluminum Screen Bracket		6
	PLEX-BR-AL-T	"T" Aluminum Screen Bracket		7
	PLEX-BR-AL-X	"X" Aluminum Screen Bracket		9

Note: Top Alignment Brackets maintain alignment and add stability to Clear Plexiglass, Frosted Acrylic, and Polycarbonate screens. Brackets feature 2-way, 3-way, or 4-way connections and are paired based on project requirements.

SAFE-T SCREENS & BARRIERS  
**Frosted Acrylic Screens**



**CONFIGURE & PRICE**

**Free-Standing Screens for Worksurfaces and Cubicles**

HARDWARE	MODEL NUMBER	DESCRIPTION	DIMENSIONS H x L x W	LIST PRICE
	SIDE SCREENS	AP1424-PS-FOOT	14" x 20.5" x 0.25"	328
		AP1430-PS-FOOT	14" x 26.5" x 0.25"	328
	FRONT SCREENS	AP1448-PS-FOOT	14" x 48" x 0.25"	521
		AP1460-PS-FOOT	14" x 60" x 0.25"	587
		AP1472-PS-FOOT	14" x 72" x 0.25"	654
	SIDE SCREENS	AP2424-PS-FOOT	24" x 20.5" x 0.25"	396
		AP2430-PS-FOOT	24" x 26.5" x 0.25"	458
	FRONT SCREENS	AP2448-PS-FOOT	24" x 48" x 0.25"	649
		AP2460-PS-FOOT	24" x 60" x 0.25"	773
		AP2472-PS-FOOT	24" x 72" x 0.25"	897
	SIDE SCREENS	AP3024-PS-FOOT	30" x 20.5" x 0.25"	753
		AP3030-PS-FOOT	30" x 26.5" x 0.25"	868
	FRONT SCREENS	AP3036-PS-FOOT	30" x 36" x 0.25"	1,015
		AP3042-PS-FOOT	30" x 42" x 0.25"	1,131
		AP3048-PS-FOOT	30" x 48" x 0.25"	1,248
		AP3060-PS-FOOT	30" x 60" x 0.25"	1,510
AP3072-PS-FOOT		30" x 72" x 0.25"	1,743	
Other Options	MAGNETS	Magnets		91
	TAPE	Heavy-Duty Double-Sided Tape		18
	<b>TOP ALIGNMENT BRACKETS</b>			
	PLEX-BR-AL-S	180° Aluminum Screen Bracket		4
	PLEX-BR-AL-L	90° "L" Aluminum Screen Bracket		6
	PLEX-BR-AL-T	"T" Aluminum Screen Bracket		7
	PLEX-BR-AL-X	"X" Aluminum Screen Bracket		9

Note: Top Alignment Brackets maintain alignment and add stability to Clear Plexiglass, Frosted Acrylic, and Polycarbonate screens. Brackets feature 2-way, 3-way, or 4-way connections and are paired based on project requirements.

Worksurface Screens with Permanent Attachment and Free-Standing Screens can be used to extend cubicle panel height. Use strong magnets, or heavy-duty double-sided tape to avoid cubicle cap damage.

SAFE-T SCREENS & BARRIERS  
**Frosted Acrylic Screens**



**Screens for Cubicle Panels with U-Brackets**

[CONFIGURE & PRICE](#)

HARDWARE	MODEL NUMBER	DESCRIPTION	DIMENSIONS H X L X W	LIST PRICE	
	SIDE SCREENS	AP1424-PS-U-BR	14" x 20.5" x 0.25"	419	
		AP1430-PS-U-BR	14" x 26.5" x 0.25"	419	
	FRONT SCREENS	AP1448-PS-U-BR	Frosted Acrylic Screen with U-Bracket Attachment for 1.875" - 2.75" Wide Panels	14" x 48" x 0.25"	612
		AP1460-PS-U-BR		14" x 60" x 0.25"	678
		AP1472-PS-U-BR		14" x 72" x 0.25"	745
	SIDE SCREENS	AP2424-PS-U-BR		24" x 20.5" x 0.25"	487
		AP2430-PS-U-BR		24" x 26.5" x 0.25"	549
	FRONT SCREENS	AP2448-PS-U-BR		24" x 48" x 0.25"	740
		AP2460-PS-U-BR	24" x 60" x 0.25"	864	
		AP2472-PS-U-BR	24" x 72" x 0.25"	988	
	SIDE SCREENS	AP3024-PS-U-BR	30" x 20.5" x 0.25"	844	
		AP3030-PS-U-BR	30" x 26.5" x 0.25"	959	
	FRONT SCREENS	AP3036-PS-U-BR	30" x 36" x 0.25"	1,106	
		AP3042-PS-U-BR	30" x 42" x 0.25"	1,222	
		AP3048-PS-U-BR	30" x 48" x 0.25"	1,339	
		AP3060-PS-U-BR	30" x 60" x 0.25"	1,601	
AP3072-PS-U-BR		30" x 72" x 0.25"	1,834		
Other Options	U-BR-XL	Up-charge for Extra Large U-Brackets for 2.75" - 4.75" Wide Panels		242	
	<b>TOP ALIGNMENT BRACKETS</b>				
	PLEX-BR-AL-S	180° Aluminum Screen Bracket		4	
	PLEX-BR-AL-L	90° "L" Aluminum Screen Bracket		6	
	PLEX-BR-AL-T	"T" Aluminum Screen Bracket		7	
	PLEX-BR-AL-X	"X" Aluminum Screen Bracket		9	

Note: Top Alignment Brackets maintain alignment and add stability to Clear Plexiglass, Frosted Acrylic, and Polycarbonate screens. Brackets feature 2-way, 3-way, or 4-way connections and are paired based on project requirements.

SAFE-T SCREENS & BARRIERS  
**Polycarbonate Screens**



**Worksurface and Cubicle Screens - Permanent Attachment**

HARDWARE	MODEL NUMBER		DESCRIPTION	DIMENSIONS H X L X W	LIST PRICE
	SIDE SCREENS	POLY1424-PS-BR	Polycarbonate Screen with Permanent Attachment Brackets	14" x 23.5" x 0.25"	261
		POLY1430-PS-BR		14" x 29.5" x 0.25"	285
	FRONT SCREENS	POLY1436-PS-BR		14" x 36" x 0.25"	346
		POLY1442-PS-BR		14" x 42" x 0.25"	394
		POLY1448-PS-BR		14" x 48" x 0.25"	402
		POLY1460-PS-BR		14" x 60" x 0.25"	494
		POLY1472-PS-BR		14" x 72" x 0.25"	565
	SIDE SCREENS	POLY2424-PS-BR		24" x 23.5" x 0.25"	356
		POLY2430-PS-BR		24" x 29.5" x 0.25"	412
	FRONT SCREENS	POLY2436-PS-BR		24" x 36" x 0.25"	491
		POLY2442-PS-BR		24" x 42" x 0.25"	594
		POLY2448-PS-BR		24" x 48" x 0.25"	623
		POLY2460-PS-BR		24" x 60" x 0.25"	740
		POLY2472-PS-BR		24" x 72" x 0.25"	853
	SIDE SCREENS	POLY3024-PS-BR		30" x 23.5" x 0.25"	484
		POLY3030-PS-BR		30" x 29.5" x 0.25"	575
	FRONT SCREENS	POLY3036-PS-BR		30" x 36" x 0.25"	635
		POLY3042-PS-BR		30" x 42" x 0.25"	635
		POLY3048-PS-BR		30" x 48" x 0.25"	666
		POLY3060-PS-BR		30" x 60" x 0.25"	1,345
POLY3072-PS-BR		30" x 72" x 0.25"	1,345		
Other Options	<b>TOP ALIGNMENT BRACKETS</b>				
	PLEX-BR-AL-S	180° Aluminum Screen Bracket	4		
	PLEX-BR-AL-L	90° "L" Aluminum Screen Bracket	6		
	PLEX-BR-AL-T	"T" Aluminum Screen Bracket	7		
	PLEX-BR-AL-X	"X" Aluminum Screen Bracket	9		

Note: Top Alignment Brackets maintain alignment and add stability to Clear Plexiglass, Frosted Acrylic, and Polycarbonate screens. Brackets feature 2-way, 3-way, or 4-way connections and are paired based on project requirements.

SAFE-T SCREENS & BARRIERS  
**Polycarbonate Screens**



**Free-Standing or Permanent Attachment Screens**

HARDWARE	MODEL NUMBER		DESCRIPTION	DIMENSIONS H X L X W	LIST PRICE
	SIDE SCREENS	POLY1424-PS-TMB	Polycarbonate Screen with Permanent Attachment or Optional Double-Sided Tape	14" x 23.5" x 0.25"	287
		POLY1430-PS-TMB		14" x 29.5" x 0.25"	311
	FRONT SCREENS	POLY1436-PS-TMB		14" x 36" x 0.25"	372
		POLY1442-PS-TMB		14" x 42" x 0.25"	420
		POLY1448-PS-TMB		14" x 48" x 0.25"	428
		POLY1460-PS-TMB		14" x 60" x 0.25"	533
		POLY1472-PS-TMB		14" x 72" x 0.25"	604
	SIDE SCREENS	POLY2424-PS-TMB		24" x 23.5" x 0.25"	382
		POLY2430-PS-TMB		24" x 29.5" x 0.25"	438
	FRONT SCREENS	POLY2436-PS-TMB		24" x 36" x 0.25"	517
		POLY2442-PS-TMB		24" x 42" x 0.25"	633
		POLY2448-PS-TMB		24" x 48" x 0.25"	662
		POLY2460-PS-TMB		24" x 60" x 0.25"	779
		POLY2472-PS-TMB		24" x 72" x 0.25"	892
	SIDE SCREENS	POLY3024-PS-TMB		30" x 23.5" x 0.25"	510
		POLY3030-PS-TMB		30" x 29.5" x 0.25"	601
	FRONT SCREENS	POLY3036-PS-TMB		30" x 36" x 0.25"	674
		POLY3042-PS-TMB		30" x 42" x 0.25"	674
		POLY3048-PS-TMB		30" x 48" x 0.25"	705
		POLY3060-PS-TMB		30" x 60" x 0.25"	1,397
POLY3072-PS-TMB		30" x 72" x 0.25"	1,397		
Other Options	TAPE		Heavy-Duty Double-Sided Tape		18
	<b>TOP ALIGNMENT BRACKETS</b>				
	PLEX-BR-AL-S		180° Aluminum Screen Bracket		4
	PLEX-BR-AL-L		90° "L" Aluminum Screen Bracket		6
	PLEX-BR-AL-T		"T" Aluminum Screen Bracket		7
	PLEX-BR-AL-X		"X" Aluminum Screen Bracket		9

Note: Top Alignment Brackets maintain alignment and add stability to Clear Plexiglass, Frosted Acrylic, and Polycarbonate screens. Brackets feature 2-way, 3-way, or 4-way connections and are paired based on project requirements.

SAFE-T SCREENS & BARRIERS  
**Polycarbonate Screens**



**Worksurface Screens with Removable C-Clamp**

HARDWARE	MODEL NUMBER		DESCRIPTION	DIMENSIONS H X L X W	LIST PRICE
	SIDE SCREENS	POLY1424-PS-C-BR	Polycarbonate Screen with C-Clamp Attachment	14" x 23.5" x 0.25"	382
		POLY1430-PS-C-BR		14" x 29.5" x 0.25"	406
	FRONT SCREENS	POLY1436-PS-C-BR		14" x 36" x 0.25"	467
		POLY1442-PS-C-BR		14" x 42" x 0.25"	515
		POLY1448-PS-C-BR		14" x 48" x 0.25"	523
		POLY1460-PS-C-BR		14" x 60" x 0.25"	615
		POLY1472-PS-C-BR		14" x 72" x 0.25"	686
	SIDE SCREENS	POLY2424-PS-C-BR		24" x 23.5" x 0.25"	477
		POLY2430-PS-C-BR		24" x 29.5" x 0.25"	533
	FRONT SCREENS	POLY2436-PS-C-BR		24" x 36" x 0.25"	612
		POLY2442-PS-C-BR		24" x 42" x 0.25"	715
		POLY2448-PS-C-BR		24" x 48" x 0.25"	744
		POLY2460-PS-C-BR		24" x 60" x 0.25"	861
		POLY2472-PS-C-BR		24" x 72" x 0.25"	974
	SIDE SCREENS	POLY3024-PS-C-BR		30" x 23.5" x 0.25"	605
		POLY3030-PS-C-BR		30" x 29.5" x 0.25"	696
	FRONT SCREENS	POLY3036-PS-C-BR		30" x 36" x 0.25"	756
		POLY3042-PS-C-BR		30" x 42" x 0.25"	756
		POLY3048-PS-C-BR		30" x 48" x 0.25"	787
		POLY3060-PS-C-BR		30" x 60" x 0.25"	1,466
POLY3072-PS-C-BR		30" x 72" x 0.25"	1,466		
Other Options	<b>TOP ALIGNMENT BRACKETS</b>				
	PLEX-BR-AL-S	180° Aluminum Screen Bracket	4		
	PLEX-BR-AL-L	90° "L" Aluminum Screen Bracket	6		
	PLEX-BR-AL-T	"T" Aluminum Screen Bracket	7		
	PLEX-BR-AL-X	"X" Aluminum Screen Bracket	9		

Note: Top Alignment Brackets maintain alignment and add stability to Clear Plexiglass, Frosted Acrylic, and Polycarbonate screens. Brackets feature 2-way, 3-way, or 4-way connections and are paired based on project requirements.

SAFE-T SCREENS & BARRIERS  
**Polycarbonate Screens**



**Free-Standing Screens for Worksurfaces and Cubicles**

HARDWARE	MODEL NUMBER	DESCRIPTION	DIMENSIONS H X L X W	LIST PRICE
	SIDE SCREENS	POLY1424-PS-FOOT	14" x 23.5" x 0.25"	382
		POLY1430-PS-FOOT	14" x 29.5" x 0.25"	406
	FRONT SCREENS	POLY1436-PS-FOOT	14" x 36" x 0.25"	467
		POLY1442-PS-FOOT	14" x 42" x 0.25"	515
		POLY1448-PS-FOOT	14" x 48" x 0.25"	523
		POLY1460-PS-FOOT	14" x 60" x 0.25"	615
		POLY1472-PS-FOOT	14" x 72" x 0.25"	686
	SIDE SCREENS	POLY2424-PS-FOOT	24" x 23.5" x 0.25"	477
		POLY2430-PS-FOOT	24" x 29.5" x 0.25"	533
	FRONT SCREENS	POLY2436-PS-FOOT	24" x 36" x 0.25"	612
		POLY2442-PS-FOOT	24" x 42" x 0.25"	715
		POLY2448-PS-FOOT	24" x 48" x 0.25"	744
		POLY2460-PS-FOOT	24" x 60" x 0.25"	861
		POLY2472-PS-FOOT	24" x 72" x 0.25"	974
	SIDE SCREENS	POLY3024-PS-FOOT	30" x 23.5" x 0.25"	605
		POLY3030-PS-FOOT	30" x 29.5" x 0.25"	696
	FRONT SCREENS	POLY3036-PS-FOOT	30" x 36" x 0.25"	756
		POLY3042-PS-FOOT	30" x 42" x 0.25"	756
		POLY3048-PS-FOOT	30" x 48" x 0.25"	787
		POLY3060-PS-FOOT	30" x 60" x 0.25"	1,466
POLY3072-PS-FOOT		30" x 72" x 0.25"	1,466	
Other Options	MAGNETS	Magnets		91
	TAPE	Heavy-Duty Double-Sided Tape		18
	<b>TOP ALIGNMENT BRACKETS</b>			
	PLEX-BR-AL-S	180° Aluminum Screen Bracket		4
	PLEX-BR-AL-L	90° "L" Aluminum Screen Bracket		6
	PLEX-BR-AL-T	"T" Aluminum Screen Bracket		7
	PLEX-BR-AL-X	"X" Aluminum Screen Bracket		9

Note: Top Alignment Brackets maintain alignment and add stability to Clear Plexiglass, Frosted Acrylic, and Polycarbonate screens. Brackets feature 2-way, 3-way, or 4-way connections and are paired based on project requirements.

Worksurface Screens with Permanent Attachment and Free-Standing Screens can be used to extend cubicle panel height. Use strong magnets, or heavy-duty double-sided tape to avoid cubicle cap damage.

SAFE-T SCREENS & BARRIERS  
**Polycarbonate Screens**



**Screens for Cubicle Panels with U-Brackets**

HARDWARE	MODEL NUMBER	DESCRIPTION	DIMENSIONS H X L X W	LIST PRICE
	SIDE SCREENS	POLY1424-PS-U-BR	14" x 23.5" x 0.25"	473
		POLY1430-PS-U-BR	14" x 29.5" x 0.25"	497
	FRONT SCREENS	POLY1436-PS-U-BR	14" x 36" x 0.25"	558
		POLY1442-PS-U-BR	14" x 42" x 0.25"	606
		POLY1448-PS-U-BR	14" x 48" x 0.25"	614
		POLY1460-PS-U-BR	14" x 60" x 0.25"	706
		POLY1472-PS-U-BR	14" x 72" x 0.25"	777
	SIDE SCREENS	POLY2424-PS-U-BR	24" x 23.5" x 0.25"	568
		POLY2430-PS-U-BR	24" x 29.5" x 0.25"	624
	FRONT SCREENS	POLY2436-PS-U-BR	24" x 36" x 0.25"	703
		POLY2442-PS-U-BR	24" x 42" x 0.25"	806
		POLY2448-PS-U-BR	24" x 48" x 0.25"	835
		POLY2460-PS-U-BR	24" x 60" x 0.25"	952
		POLY2472-PS-U-BR	24" x 72" x 0.25"	1,065
	SIDE SCREENS	POLY3024-PS-U-BR	30" x 23.5" x 0.25"	696
		POLY3030-PS-U-BR	30" x 29.5" x 0.25"	787
	FRONT SCREENS	POLY3036-PS-U-BR	30" x 36" x 0.25"	847
		POLY3042-PS-U-BR	30" x 42" x 0.25"	847
		POLY3048-PS-U-BR	30" x 48" x 0.25"	878
		POLY3060-PS-U-BR	30" x 60" x 0.25"	1,557
POLY3072-PS-U-BR		30" x 72" x 0.25"	1,557	
Other Options	U-BR-XL	Up-charge for Extra Large U-Brackets for 2.75" - 4.75" Wide Panels		242
	<b>TOP ALIGNMENT BRACKETS</b>			
	PLEX-BR-AL-S	180° Aluminum Screen Bracket		4
	PLEX-BR-AL-L	90° "L" Aluminum Screen Bracket		6
	PLEX-BR-AL-T	"T" Aluminum Screen Bracket		7
	PLEX-BR-AL-X	"X" Aluminum Screen Bracket		9

**Note:** Top Alignment Brackets maintain alignment and add stability to Clear Plexiglass, Frosted Acrylic, and Polycarbonate screens. Brackets feature 2-way, 3-way, or 4-way connections and are paired based on project requirements.



# PET Screens



## Worksurface and Cubicle Screens - Permanent Attachment

[CONFIGURE & PRICE](#)

HARDWARE	MODEL NUMBER		DESCRIPTION	DIMENSIONS H x L x W	LIST PRICE
	SIDE SCREENS	PET1424-PS-BR	PET Screen with Permanent Attachment Brackets	13.75" x 22" x 0.5"	251
		PET1430-PS-BR		13.75" x 28" x 0.5"	337
	FRONT SCREENS	PET1448-PS-BR		13.75" x 48" x 0.5"	391
		PET1460-PS-BR		13.75" x 60" x 0.5"	533
		PET1472-PS-BR		13.75" x 72" x 0.5"	590
	SIDE SCREENS	PET2424-PS-BR		23.75" x 22" x 0.5"	388
		PET2430-PS-BR		23.75" x 28" x 0.5"	478
	FRONT SCREENS	PET2448-PS-BR		23.75" x 48" x 0.5"	537
		PET2460-PS-BR		23.75" x 60" x 0.5"	740
		PET2472-PS-BR		23.75" x 72" x 0.5"	790

## Free-Standing or Permanent Attachment Screens

[CONFIGURE & PRICE](#)

HARDWARE	MODEL NUMBER		DESCRIPTION	DIMENSIONS H x L x W	LIST PRICE
	SIDE SCREENS	PET1424-PS-TMB	PET Screen with Permanent Attachment or Optional Double-Sided Tape	13.75" x 22" x 0.5"	277
		PET1430-PS-TMB		13.75" x 28" x 0.5"	363
	FRONT SCREENS	PET1448-PS-TMB		13.75" x 48" x 0.5"	417
		PET1460-PS-TMB		13.75" x 60" x 0.5"	572
		PET1472-PS-TMB		13.75" x 72" x 0.5"	629
	SIDE SCREENS	PET2424-PS-TMB		23.75" x 22" x 0.5"	414
		PET2430-PS-TMB		23.75" x 28" x 0.5"	504
	FRONT SCREENS	PET2448-PS-TMB		23.75" x 48" x 0.5"	576
		PET2460-PS-TMB		23.75" x 60" x 0.5"	779
		PET2472-PS-TMB		23.75" x 72" x 0.5"	829
Other Options	TAPE	Heavy-Duty Double-Sided Tape		18	

# PET Screens

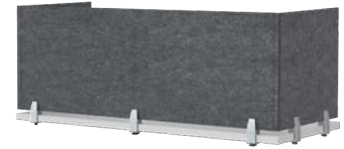

## Worksurface Screens with Removable C-Clamp

[CONFIGURE & PRICE](#)

HARDWARE	MODEL NUMBER		DESCRIPTION	DIMENSIONS H x L x W	LIST PRICE
	SIDE SCREENS	PET1424-PS-C-BR	PET Screen with C-Clamp Attachment	13.75" x 22" x 0.5"	372
		PET1430-PS-C-BR		13.75" x 28" x 0.5"	458
	FRONT SCREENS	PET1448-PS-C-BR		13.75" x 48" x 0.5"	512
		PET1460-PS-C-BR		13.75" x 60" x 0.5"	654
		PET1472-PS-C-BR		13.75" x 72" x 0.5"	711
	SIDE SCREENS	PET2424-PS-C-BR		23.75" x 22" x 0.5"	509
		PET2430-PS-C-BR		23.75" x 28" x 0.5"	599
	FRONT SCREENS	PET2448-PS-C-BR		23.75" x 48" x 0.5"	658
		PET2460-PS-C-BR		23.75" x 60" x 0.5"	861
		PET2472-PS-C-BR		23.75" x 72" x 0.5"	911

## Free-Standing Screens for Worksurfaces and Cubicles

[CONFIGURE & PRICE](#)

HARDWARE	MODEL NUMBER		DESCRIPTION	DIMENSIONS H x L x W	LIST PRICE
	SIDE SCREENS	PET1424-PS-FOOT	PET Screen with Free-Standing Foot	13.75" x 22" x 0.5"	372
		PET1430-PS-FOOT		13.75" x 28" x 0.5"	458
	FRONT SCREENS	PET1448-PS-FOOT		13.75" x 48" x 0.5"	512
		PET1460-PS-FOOT		13.75" x 60" x 0.5"	654
		PET1472-PS-FOOT		13.75" x 72" x 0.5"	711
	SIDE SCREENS	PET2424-PS-FOOT		23.75" x 22" x 0.5"	509
		PET2430-PS-FOOT		23.75" x 28" x 0.5"	599
	FRONT SCREENS	PET2448-PS-FOOT		23.75" x 48" x 0.5"	658
		PET2460-PS-FOOT		23.75" x 60" x 0.5"	861
		PET2472-PS-FOOT		23.75" x 72" x 0.5"	911
Other Options	MAGNETS		Magnets		91
	TAPE		Heavy-Duty Double-Sided Tape		18

Worksurface Screens with Permanent Attachment and Free-Standing Screens can be used to extend cubicle panel height. Use strong magnets, or heavy-duty double-sided tape to avoid cubicle cap damage.

# PET Screens



## Screens for Cubicle Panels with U-Brackets

[CONFIGURE & PRICE](#)

HARDWARE	MODEL NUMBER		DESCRIPTION	DIMENSIONS H x L x W	LIST PRICE	
	SIDE SCREENS	PET1424-PS-U-BR	PET Screen with U-Bracket for 1.875" - 2.75 Wide Panels	13.75" x 22" x 0.5"	463	
		PET1430-PS-U-BR		13.75" x 28" x 0.5"	549	
	FRONT SCREENS	PET1448-PS-U-BR		13.75" x 48" x 0.5"	603	
		PET1460-PS-U-BR		13.75" x 60" x 0.5"	745	
		PET1472-PS-U-BR		13.75" x 72" x 0.5"	802	
	SIDE SCREENS	PET2424-PS-U-BR		23.75" x 22" x 0.5"	600	
		PET2430-PS-U-BR		23.75" x 28" x 0.5"	690	
	FRONT SCREENS	PET2448-PS-U-BR		23.75" x 48" x 0.5"	749	
		PET2460-PS-U-BR		23.75" x 60" x 0.5"	952	
		PET2472-PS-U-BR		23.75" x 72" x 0.5"	1,002	
	Other Options	U-BR-XL		Up-charge for Extra Large U-Brackets for 2.75" - 4.75" Wide Panels	242	

SAFE-T SCREENS & BARRIERS

**PET Screens**

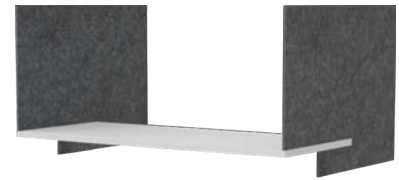

HARDWARE	MODEL NUMBER	DESCRIPTION	DIMENSIONS H x L x W	LIST PRICE
----------	--------------	-------------	-------------------------	------------

**Privacy/Modesty Screens**

**CONFIGURE & PRICE**

	PET2448-PS/MP	PET Privacy/Modesty Screen with Permanent Attachment	23.75" x 48" x 0.5"	491
	PET2460-PS/MP		23.75" x 60" x 0.5"	715
	PET2472-PS/MP		23.75" x 72" x 0.5"	766

**Modesty Panels**

**CONFIGURE & PRICE**

	PET-1048-MP	PET Modesty Panel	10" x 48" x 0.5"	311
	PET-1060-MP		10" x 60" x 0.5"	487
	PET-1072-MP		10" x 72" x 0.5"	542

**Sliding Desk Divider**

**CONFIGURE & PRICE**

	PET2424-EXT	PET Sliding Desk Divider Screen for 24"D Worksurface, 24" above surface	30" x 42" x 1"	1,021
	PET2430-EXT	PET Sliding Desk Divider Screen for 30"D Worksurface, 24" above surface	30" x 48" x 1"	1,041



## STANDARD TABLE FEATURES

## STANDARD TABLE FEATURES

Special-T tables are manufactured from the highest quality products possible, meeting or exceeding ANSI/BIFMA standards.

HPL tabletops feature 1-1/8" thick 45 lb. density particle board core, high-pressure laminate, durable vinyl, wood or urethane edges, and .038 balanced backer sheet on less than 48" tables (.038 phenolic backer equal or greater than 48"). The finished top thickness is 1-1/4".

High-quality high-pressure Standard WilsonArt laminates are available for tops. Premium laminates are available for an additional charge.

TFL tabletops feature 1" low pressure, 45 lb density core, low-pressure laminate on both sides, and matching color vinyl edge.

A wide selection of table edges and edge colors are available. Edge options include durable vinyl, wood, and urethane edges.

Most tops are pre-drilled for easy installation. In addition, all 60" or longer tables sold without a continuous beam base include a steel table support to prevent tops from sagging.

Table legs feature high-quality tubular steel, stainless steel, cast aluminum, or cast iron. All tubular steel bases are available in 20 powder coat finishes at the standard price. Color matching is available; an upcharge may apply. Some bases are also available in polished chrome and stainless steel finishes. Leveling glides are standard for most tables. Tables legs ship knocked down and are easy to assemble.

The standard table height is 29".

Special-T demonstrates its dedication to the future of our environment in its products. Special-T products have passed stringent MAS Certificated Green™ Indoor Air Quality testing and comply with BIFMA X7.1, LEED, CDPH, and SHPS standards\*.

\*Wood edges are not MAS Certificated Green™



## WARRANTY & RETURN POLICY



## WARRANTY & RETURN

### WARRANTY

May 15, 2020

*To expedite your warranty claims quickly and accurately, go to [specialt.net/claims](http://specialt.net/claims) and fill out the Warranty/Freight claim form. All claims must reference the original Purchase Order number and Special-T Sales Order or Invoice number.*

**Options+, 5-Day Quick Ship, and 1-Day Quick Ship Tables.** Complete tables and all components included therein are warranted for 10 years from the date of the original invoice against poor workmanship and manufacturing defects. We retain the right to replace or repair at our discretion any products or parts thereof which are found defective in materials or workmanship. This warranty becomes invalid for products engineered by the client, whereas the construction method, material specifications of final product assembly adversely affect materials and or workmanship. In no event shall liability under this warranty exceed the original purchase price. This warranty becomes invalid if the product or part exhibits abuse, improper or unusual use, including striking tops against other objects. This warranty is invalid if the product is subject to caustic or abrasive cleaning agents or any alterations from its original condition. This warranty does not cover self-edge tops and/or tables where table legs/bases are more than 60" apart and do not include steel top support. Our tables and tabletops are not for outdoor use. Any damage related to outdoor use is not covered under this warranty. This warranty does not apply to normal wear and tear or damage caused by accident, neglect, misuse, or improper installation or operation. This warranty is expressly made in lieu of any, and all other warranties expressed or implied.

**Patriot Electric and Liberty Electric Height Adjustable Tables and Bases** are warranted to the original purchaser for 10 years from the date of delivery, under normal use for one, 8-hour shift per day against manufacturing defects. We will repair or replace, at our discretion, any products that we determine to be defective as a result of faulty workmanship. In no event shall our liability under this warranty exceed the original purchase price of the product determined to be defective. This warranty does not apply where the product has been abused, mishandled, or subjected to use other than that for which it was designed. For purposes of this warranty, normal wear to the product finish shall not be considered a defect.

**Table Bases Only.** Bases are warranted to the original purchaser for 10 years from the date of delivery, under normal use, against manufacturing defects. We will repair or replace, at our discretion, any products that we determine to be defective as a result of faulty workmanship. In no event shall liability under this warranty exceed the original purchase price of the product determined to be defective. This warranty does not apply where the product has been abused, mishandled, or subjected to use other than that for which it was designed, including excessive weight and top size limitations. This warranty does not apply to normal wear and tear or damage caused by accident, neglect, misuse, or improper installation or operation. There are no other warranties expressed or implied.

**Tabletops Only.** Tabletops purchased separately are warranted for one (1) year from the original invoice date against poor workmanship and manufacturing defects. We retain the right to replace or repair at our discretion any products or parts thereof which are found defective in materials or workmanship. This warranty becomes invalid for products engineered by the client, whereas the construction method and material specifications of final product assembly adversely affect materials and workmanship. In no event shall liability under this warranty exceed the original purchase price. This warranty becomes invalid if the product or parts exhibits abuse, improper or unusual use. This warranty is invalid if the product is subject to caustic or abrasive cleaning agents or sharp objects that cause damage. This warranty is invalid if the product is altered from its original condition or the client performs additional processing on the product that results in any alteration from its original condition. This warranty does not cover self edge tops and/or tops where table legs/bases are more than 60" apart and do not include steel top support. Our tables and tabletops are not for outdoor use. Any damage related to outdoor use is not covered under this warranty. This warranty does not apply to normal wear and tear or damage caused by accident, neglect, misuse, or improper installation or operation. This warranty is expressly made in lieu of any, and all other warranties expressed or implied.

Customer Service:



888.705.0777



[customerservice@specialt.net](mailto:customerservice@specialt.net)

### CONTACT INFORMATION

Warranty:



888.705.0777



[warranty@specialt.net](mailto:warranty@specialt.net)





# WARRANTY & RETURN

## WARRANTY

May 15, 2020

**Wood Veneer.** Special-T warrants that wood veneer tops shall be free of defects in workmanship or materials. All wood veneer tops will be built to the customer's specifications. All defective product claims must be submitted in writing to Special-T within 30 days of the shipping date from Special-T. Special-T may request samples, photos, or videos demonstrating the defect for all defective product claims before further action. No merchandise shall be returned or scrapped without prior approval from Special-T. Special-T reserves the right to refuse and return all unauthorized returns to the customer. Special-T Quality Inspection Department must confirm tops to be defective before the replacement process can begin. This warranty excludes any misuse, abuse, as well as ordinary wear and tear. The foregoing warranty shall not apply to damage caused under the following circumstances: a) modifications or attachments to Special-T products, b) damage caused by misapplication of cleaning products, c) natural variations in wood grain, figure, color or the presence of character marks, d) any handling or transportation damage to the products, e) changes in the surface finishes due to aging or exposure to light.

**Power & Data:** All Power and Data components are warranted for 1 year from the date of the original invoice against poor workmanship and manufacturing defects. This warranty becomes invalid for products engineered by the client, whereas the construction method, material specifications of final product assembly adversely affect materials and or workmanship. In no event shall liability under this warranty exceed the original purchase price. This warranty does not apply to normal wear and tear or damage caused by accident, neglect, misuse, or improper installation or operation.

**Monitor Arms** are warranted to the original purchaser for 10 years from the delivery date, under normal use for one, 8-hour shift per day, against manufacturing defects. We will repair or replace, at our discretion, any products that we determine to be defective as a result of faulty workmanship. In no event shall our liability under this warranty exceed the original purchase price of the product determined to be defective. This warranty does not apply where the product has been abused, mishandled, or subjected to use other than that for which it was designed. This warranty does not apply to normal wear and tear or damage caused by accident, neglect, misuse, or improper installation or operation.

**Chairs:** Special-T warrants to the original purchaser of the product and from the original date of sale the following: Lifetime Warranty to the original end-user; the company will repair or replace, at its option, factory defective structural and mechanical parts with a comparable product without charge. This warranty is for a single shift, standard commercial usage, defined as a standard 8-hour workday, five days a week. Weight limitation varies by product. Upholstery fabric and foam are warranted against wear through and deterioration during normal usage for five (5) years. COM and COL are not warranted.

**Wellness and Privacy Screens:** Clear Plexiglass, Frosted Acrylic, and PET Wellness and Privacy Screens are warranted for 10 years from the date of delivery against defects in materials or workmanship, subject to the limitations exclusions, and other provisions detailed below. This limited warranty only applies to the original purchaser. The limited warranty is terminated upon transfer, sale, or modification of the product. In no event shall liability under this warranty exceed the original purchase price. This warranty does not apply to normal wear and tear or damage caused by accident, neglect, abuse, misuse, vandalism, disaster, improper storage, improper cleaning, chemical damage, improper installation, operation, environmental factors, or discoloration due to sunlight or indoor lighting. This warranty does not apply to changes in surface finish due to aging or prolonged exposure to fluids or sun. In the event of repair and/or replacement of any defective product, Special-T does not warrant matching color, texture, or dye lots except within commercially reasonable standards. This warranty is expressly made in lieu of any and all other warranties expressed or implied.

**Labor Warranty** is subject to written approval. It does not cover labor costs associated with concealed freight damage.

Customer Service:



888.705.0777



customerservice@specialt.net

### CONTACT INFORMATION

Warranty:



888.705.0777



warranty@specialt.net



## WARRANTY & RETURN

Customer Service:



888.705.0777



customerservice@specialt.net

### CONTACT INFORMATION

Warranty:



888.705.0777



warranty@specialt.net

### RETURN POLICY

The Return of any merchandise to the Special-T, LLC, warehouse must be authorized prior to shipment.

- All returns must be accompanied by a Return Merchandise Authorization Form (RMA). The RMA must be requested within thirty (30) days of the original invoice date. Please contact Customer Service at 888.705.0777, Monday to Friday, 8:00 am to 5:00 PM EST. Upon approval of the return, send the prepaid shipment to 11820 Wills Road, Suite 140, Alpharetta, GA 30009-0256.
  - Tops - 30% restocking fee will apply if received in new condition
  - Bases - 25% restocking fee will apply if received in new condition
  - Products must be in new condition and in original carton
- The following items are non-returnable and non-refundable:
    - Custom table tops
    - Power and data units
    - Closeout tables and bases
    - Custom metal paint and Black Wrinkle finish
    - Metal bases with irreversible alterations

Cancellation Charges. There will be no cancellation charges prior to production. After production, the actual cost incurred will be assessed if the product cannot be sold after a six (6) month period.



## COLOR OPTIONS

## QUICK SHIP TOP & EDGE COLOR OPTIONS

### 1-DAY QUICK SHIP TFL



CREMA  
MAPLE



AGED  
DRIFTWOOD

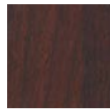

MAHOGANY\*

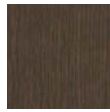

ESPRESSO



WHITE



LIGHT GRAY



CANVAS

### 5-DAY QUICK SHIP HPL



KENSINGTON  
MAPLE



WILD  
CHERRY



JUDICIAL  
WALNUT\*



MOCHA\*

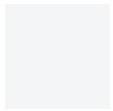

DESIGNER  
WHITE

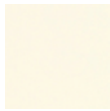

ANTIQUE  
WHITE



FASHION  
GREY



SHADOW



BLACK



TUNGSTEN  
EV



WHITE  
NEBULA



TITANIUM  
EV

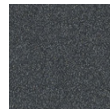

GRAPHITE  
NEBULA

Standard laminate - no upcharge | Edges match the laminate color and pattern  
Images are representative of the material and may not be an exact match.

\*Premium colors - 10% upcharge | \*While supplies last

# OPTIONS+ TOP COLORS

## HPL WOODGRAIN



WHITE  
DRIFTWOOD\*



GREY ELM\*



KENSINGTON  
MAPLE



BRAZILWOOD



RIVER  
CHERRY



WILD  
CHERRY



WILLIAMS-  
BURG  
CHERRY\*



JUDICIAL  
WALNUT\*



EMPIRE  
MAHOGANY\*



COCOBALA\*



MOCHA\*



COLOMBIAN  
WALNUT\*



STUDIO  
TEAK\*



SKYLINE  
WALNUT\*



ASIAN  
NIGHT\*



XANADU\*



EBONY  
RECON

## HPL SOLID COLORS

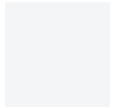

DESIGNER  
WHITE



ANTIQUE  
WHITE



KHAKI  
BROWN



PEPPERDUST



SHADOW



FASHION  
GREY



DOVE GREY



NORTH SEA



SLATE GREY

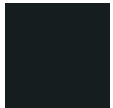

BLACK

## HPL PATTERN DESIGN



WHITE  
TIGRIS



CRISP  
LINEN

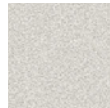

WHITE  
NEBULA

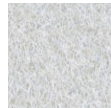

TITANIUM  
EV



DESERT  
ZEPHYR

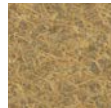

TUNGSTEN  
EV

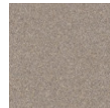

CANYON  
ZEPHYR

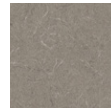

EVENING  
TIGRIS



CARBON EV



TWILIGHT  
ZEPHYR

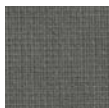

STEEL  
MESH

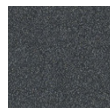

GRAPHITE  
NEBULA

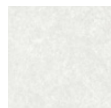

GREY  
PAMPAS

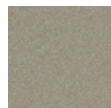

LODEN  
ZEPHYR



MISTED  
ZEPHYR

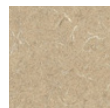

NATURAL  
TIGRIS

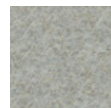

NICKEL



PEWTER  
BRUSH

Select any WilsonArt or Formica laminates | Standard laminate - no upcharge | \*Premium colors - 10% upcharge  
Images are representative of the material and may not be an exact match.

# OPTIONS+ TOP COLORS

## WOOD VENEER



PEARL  
OAK (08)



KENSINGTON  
MAPLE (26)



NATURAL OAK  
(08)



UPTOWN  
WALNUT (17)



WILD CHERRY  
(03)



BILTMORE  
CHERRY (15)



COTTAGE  
OAK (13)



AGED  
OAK (10)



CARBON  
TEAK\* (25)



HAMPTON  
WALNUT (04)



CAFELLE ASH  
(21)

Edges match the laminate color and pattern | Wood veneer custom stain matches are available for a fee of \$300 Net  
Images are representative of the material and may not be an exact match.

\*Premium Colors

# EDGES & TOP OPTIONS

## STANDARD VINYL EDGES



**P3**  
3MM VINYL



**P3R**  
ROUNDED  
CORNERS 3MM  
VINYL



**PK**  
KNIFE EDGE

## HPL WOODGRAIN



**WHITE  
DRIFTWOOD\***



**GREY ELM\***



**KENSINGTON  
MAPLE**



**BRAZIL-  
WOOD**



**RIVER  
CHERRY**



**WILD  
CHERRY**



**WILLIAMS-  
BURG  
CHERRY\***



**JUDICIAL  
WALNUT\***



**EMPIRE  
MAHOGANY\***

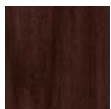

**COCOBALA\***



**MOCHA\***

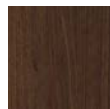

**COLOMBIAN  
WALNUT\***

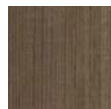

**STUDIO  
TEAK\***



**SKYLINE  
WALNUT\***



**ASIAN  
NIGHT\***



**XANADU\***



**EBONY  
RECON**

## HPL SOLID COLORS

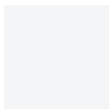

**DESIGNER  
WHITE**



**ANTIQUE  
WHITE**



**KHAKI  
BROWN**



**PEPPERDUST**



**SHADOW**



**FASHION  
GREY**



**DOVE  
GREY**



**NORTH SEA**



**SLATE GREY**

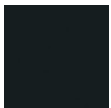

**BLACK**

Select any WilsonArt or Formica laminates | Standard laminate - no upcharge | \*Premium colors - 10% upcharge  
All edges match the laminate color and pattern  
Images are representative of the material and may not be an exact match.

# EDGES & TOP OPTIONS

## STANDARD VINYL EDGES



**P3**  
3MM VINYL



**P3R ROUNDED**  
**CORNERS 3MM**  
VINYL



**PK**  
KNIFE EDGE

## HPL PATTERN DESIGN



**WHITE**  
**TIGRIS**



**CRISP**  
**LINEN**



**WHITE**  
**NEBULA**



**TITANIUM**  
**EV**



**DESERT**  
**ZEPHYR**



**TUNGSTEN**  
**EV**



**CANYON**  
**ZEPHYR**

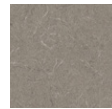

**EVENING**  
**TIGRIS**

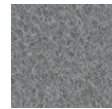

**CARBON EV**



**TWILIGHT**  
**ZEPHYR**

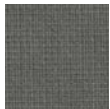

**STEEL**  
**MESH**



**GRAPHITE**  
**NEBULA**



**GREY**  
**PAMPAS /**  
**FASHION**  
**GREY\*\***

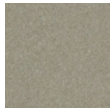

**LODEN**  
**ZEPHYR /**  
**AMAZON\*\***



**MISTED**  
**ZEPHYR**  
**/DOVE**  
**GREY\*\***



**NATURAL**  
**TIGRIS /**  
**SAND\*\***



**NICKEL /**  
**AMAZON\*\***



**PEWTER**  
**BRUSH /**  
**GRAPHITE\*\***

## PK UNDER EDGE COLORS



**PK**

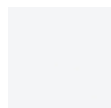

**WHITE**



**BROWN**



**GREY**



**BLACK**

Select any WilsonArt or Formica laminates | Standard laminate - no upcharge | \*Premium colors - 10% upcharge

\*\*Recommended edge color, not an exact laminate match

Images are representative of the material and may not be an exact match



## METAL FINISH COLORS

### QUICK SHIP STOCK COLORS



METALLIC  
SILVER



BLACK

### POWDER COAT COLORS

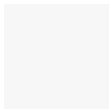

GLOSSY  
WHITE



MEDIUM  
TONE



HW  
PLATINUM



SMOKE



GRAPHITE



BLACK  
WRINKLE



IVORY



PISTACHIO



EVERGREEN



POWDER  
BLUE



AUBURN



NATURAL



METALLIC  
GOLD



COOL  
GRAY



RUBY

### METALLIC POWDER COAT COLORS



METALLIC  
SAND



GUN METAL



METALLIC  
PLATINUM

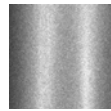

STEEL  
SILVER

### NON-POWDER COAT COLORS



STAINLESS  
STEEL\*

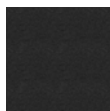

BLACK  
WRINKLE

Metal finishes vary by base style | Additional charges may apply | \*Not available in powder coat finishes  
Images are representative of the material and may not be an exact match

# PATRIOT METAL FINISH COLOR OPTIONS

## PATRIOT QUICK SHIP STOCK COLOR

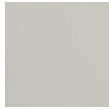

**METALLIC SILVER**  
[MS]  
METALLIC SEMI-GLOSS

## PATRIOT METAL COLORS



**BLACK**  
[B07]  
MATTE



**DESIGNER WHITE**  
[405]  
MATTE



**SOFT WHITE**  
[LU]  
MATTE

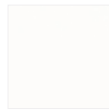

**WHITE**  
[91]  
MATTE



**ANODIZED SILVER**  
[S09]



**STARLIGHT SILVER**  
[S15]  
METALLIC SEMI-GLOSS



**WARM NEUTRAL GRAY**  
[WN]  
MATTE



**TAUPE METALLIC**  
[504]  
METALLIC SEMI-GLOSS



**MEDIUM TONE**  
[MT]  
MATTE



**METALLIC BRONZE**  
[EH]  
METALLIC SEMI-GLOSS



**CLEAR**  
[CC05]  
MATTE

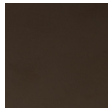

**SATIN BRONZE**  
[SB]  
MATTE



**ANTHRACITE GRAY**  
[7016]  
GLOSS



**GRAPHITE**  
[G2]  
MATTE



**CARBON METALLIC**  
[514]  
METALLIC SEMI-GLOSS



**BUMPER BLACK**  
[B05]  
GLOSS



**COPPER TOP**  
[1023]  
SEMI-GLOSS



**ORANGE**  
[OR01]  
GLOSS



**RED**  
[R02]  
GLOSS



**MOSS GREEN**  
[G01]  
GLOSS



**SIGNAL GREEN**  
[6032]  
GLOSS



**SERPO GREEN**  
[G03]  
GLOSS



**LIGHT GREEN**  
[6027]  
GLOSS



**SKY BLUE**  
[TR1J]  
MATTE

Images are representative of the material and may not be an exact match.





TABLES, BASES & ACCESSORIES



11820 Wills Rd, Suite 140,  
Alpharetta, GA 30009  
888.705.0777

[www.specialt.net](http://www.specialt.net)